

SIEMENS

Ingenuity for life



Low Voltage Switchgear
Short form catalogue
2016/17



LOW VOLTAGE SWITCHGEAR

Contact details

SIEMENS LOW VOLTAGE SWITCHGEAR

Product Promoters

Sentron Power Distribution Business Developer -

Yullen Govender

Tel : 011 652 2693
Fax : 086 215 1485
Cell : 082 891 4824

Simocode Business Developer-

Nkosinathi Zulu

Tel : 011 652 3194
Fax : 086 214 8084
Cell : 082 621 0028

Conventional Switchgear Business Developer -

Zameer Thayab

Tel : 011 652 3637
Fax : 086 5066 524
Cell : 082 745 5198

Soft Starters Business Developer -

Zukiswa Tyilana

Tel : 011 652 7464
Fax : 086 5066 533
Cell : 072 632 2291

Internal Support

Malefu Rampai

Tel : 011 652 2342

David Moela

Tel : 011 652 3290

Kishore Sooklall - KZN

Tel : 031 710 4111

Siemens PE

Tel : 041 398 5000

Siemens - CT

Tel : 021 935 8000

Siemens Call Center -

Tel: 0860 80 80 80

Email: iadquotes.za@siemens.com

HEAD OFFICE - GAUTENG

300 Janadel Avenue
Halfway House
Midrand
Tel : 011 652 2000
Tech Support : 0860 80 80 80
Orders Fax : 086 569 1333

KWAZULU NATAL

37 Gillits Road
Pinetown
KZN
Tel : 031 710 4111
Fax : 031 710 4129

CAPE TOWN

163 Hendrik Verwoerd Drive
Platteklouf
Cape Town

Tel : 021 935 8000
Fax : 021 935 8016

PORT ELIZABETH

65 Newton Street
Port Elizabeth

Tel : 041 398 5000
Fax : 041 398 5050

LOW VOLTAGE SWITCHGEAR

Approved Siemens Partners

Johannesburg

A and A Dynamic Distributors (Pty) Ltd

20-24 Augusta Road
Regents Park
Johannesburg
011 681-5900 (T)
011 689-5927 (F)
Ebi Rahimtulla
ebrahim@aadynamic.co.za

BKB Engineering Services cc

6 Kobalt Street
Vanderbijlpark
016 931-2351 (T)
016 931-1231 (F)
Bhagoobhai Bawa
bawa@iafrica.com

Noble Motor & Control (Pty) Ltd

Cnr Houtkop & Harrington Roads
Vereeniging
016 427-4060/ 016 450-7500
016 427-4091 (F)
Robbie Noble
robbie@noblemc.co.za

Mpumalanga

Simotech

4 Volt Street
Industrial Area
Middelburg
013 246-2614 (T)
086 614 4756 (F)
Ernest Bean
ernest@simotech.com

Limpopo Province

Beam Electrical Wholesalers cc

Cnr Dikbas & Drift Streets
Onverwacht
Ellisras
014 763-3985 (T)
014 763-3853 (F)
Fanus du Plessis
beam@lantic.net

M J M Maintenance Installations cc t/a M J M Electrical

6 Leyd Street
Phalaborwa
015 781-3165 (T)
015 781-3186 (F)
Gerrit Breytenbach
mjm1@lantic.net

Northern Cape

Leclovo cc

63 Transvaal Road
Kimberley
053 833-2791 (T)
053 831-2078 (F)
Jacques Francis
jacques.francis@lantic.net

Northwest Province

Lichtenburg Technical Services cc

Cnr Nelson Mandela & Republic Streets
Lichtenburg
018 632-1531 (T)
018 632-1538 (F)
Carel Steinman
ts@telkomsa.net

Lasrust Enterprises (Pty) Ltd

16 Mangaan Street
Rustenburg X9
014 538-0441 (T)
014 538-2938 (F)
Philip Wetzlar
philip@lasrust.co.za

Eastern Cape

N A Wardle t/a Power Flo Electrical

1 Stromberg Road
Gately
East London
043 731 2001 (T)
043 731 1502 (F)
Sean Glasgow
seang@powerflo.co.za

Ubulunga Electrical t/a T W Technical Services

47 Haupth Street
Sidwell
Port Elizabeth
041 451-2202 (T)
041 451-3646 (F)
Vernon Rudiger
vernon@twts.co.za

Rubicon Electrical Distributor CC

4 Reith Str
Port Elizabeth
041 451 4359 (T)
041 451 1296 (F)
Dylan Schnetler
dylan@rubiconsa.com

LOW VOLTAGE SWITCHGEAR

Approved Siemens Partners

WESTERN CAPE

E W H Electrical cc t/a Yes Electrical

199 Voortrekker Road
Belville
021 948-8800 (T)
021 948-2180 (F)
Ellis Jansen
elnor@escct.co.za

Bi-Tron Technical Services cc

8 Pioneer Road
Pacaltsdorp, Industria
George
044 878-0062 (T)
044 878-0154 (F)
Allan Askew
allan@bitron.co.za

Victory Electrical cc

Unit 16 & 17
Point Business Park
Cnr Koeberg & Marinus Roads
Milnerton
021 555-2468 (T)
021 555-0523 (F)
Kevin Sherwin
sales@victoryelectrical.co.za

K Z N

Magnet Electrical Supplies (Pty) Ltd

2 Ibhubesi Rd, Riverhorse Valley
Riverhorse Valley
Durban
031 274-1079 (T)
031 206 0436 (F)
Kumaran Naidoo
kumarann@magnetgroup.co.za

K Z N

A R B Electrical Wholesalers (Pty) Ltd

10 Mack Road
Prospecton
031 910-0200 (T)
031 910-0299 (F)
Beran Sewath
berans@arb.co.za

Electro Sales cc

36 Victoria Road
Newcastle
034 312-2403 (T)
034 312-3625 (F)
Craig Thompson
electrosales@telkomsa.net

Trade Electrical cc

25 56th Avenue
Umhlatuzana Township
031 401-9902 (T)
031 403-5400 (F)
Teeno Singh
tradeelec@mweb.co.za

Sietech

6 Lamont Rd
Glenwood
Durban
4001
031 205-9492 (T)
Nigel Marlin
marlinn@absamail.co.za

Siemens Sivacon & Simoprime Partners

Johannesburg

Automation and Control (MCA)

64 Malcolm Moodie Crescent
Jet Park
Boksburg
Tel : +27 11 397-2141
Fax : +27 11 397-2144
Mobile: 084 383 8571
Grant Smith
grant@motorcontrol.co.za

Durban

VOLTEX LV MV SOLUTIONS

Corner R103 and Thousand Hills Street
Cato Ridge
3680
Tel : +27 31 783 4389
Cell: 071 891 5382
Luca Petersen
lpetersen@voltex.co.za

Siemens Sivacon Partners

Johannesburg

Afrilek Automation
Unit 1 & 5 Astro Place
163 van Der Blij Road
Meadowdale, 1416
Tel : +27 11 372 9340
sales@afriek.com

Western Cape

EDS Switchboards
2 Natal Street
Paarden Island
Cape Town
Tel : +27 21 510 3457
jhuman@edsswitchboards.co.za

LOW VOLTAGE SWITCHGEAR

South East African Approved Partners

Namibia

Dynamic Power Systems (DPS)

9 Albert Wessels Road,
Northern Industrial
t: +264 61 555 701
f: +264 61 254 012
E-mail christo.jordaan@dpsnam.com

Botswana

Moreflow (Pty) Ltd

Farm 716-NQ, Selepa, Botswana
[Tel:+2672416475](tel:+2672416475)
Email: goitse@moreflow.co.bw

Tanzania

Siemens (Pty) Ltd

P.O. Box 14977
Dar es Salaam
Telephone (0925522) 286-3724
Fax (0925522) 286-3735

International Energy Technik Ltd

Plot 455 Kawe, Avocado Street near Golf Club
Dar es Salaam, Tanzania
f: +255 (0)22 2781228
info@ietz.co.tz

Zambia

Intelligent System Limited (ISL)

NO 10 Madzimoyo Close, Parklands
Telephone +260 21 222 6985
Fax +260 2122 2553
Mobile +260 966 780 338
E-mail isl@isl.co.zm (Ken Simwanza)

Mauritius

IBL Technology

Unit 4, IBL Business Pk, Phase 1
Riche Terre, Mauritius
t: +2302487010
f: +2302487060
jsimonsen@iblgroup.com

Kenya

International Energy Technik (ITE)

Nairobi Business Park
Unit B, Gr. Flr
Nairobi
Tel +254 (20) 285 6000
Fax +254 (20) 285 6274

International Energy Technik Ltd

Unit 90, Alpha Centre Mombasa Road
Nairobi, Kenya
t: +254 (0)20 3541082-6
t: +254 (0)722 205 386
f: +254 (0)20 6825280
<http://www.iet.co.ke>

Lomas & Lomas Ltd

Sasio Rd Off Lunga Lunga Rd
Nairobi, Kenya
00507
t: +254 20 535538/9
f: +254 20 533883
lnl@africaonline.co.ke

Uganda

International Energy Technik Ltd

Plot 21, Lumumba Avenue
Kampala, Uganda
t: +256 (0)414 251105/6
f: +256 (0)414 251107
info@iet.co.ug

Appendix

Online Support



The comprehensive information system available round the clock via internet ranging from Product Support and Service & Support services to Support Tools in the Shop.

Technical Consulting



Support in the planning and designing of your project from detailed actual-state analysis, target definition and consulting on product and system questions right to the creation of the automation solution.

Technical Support

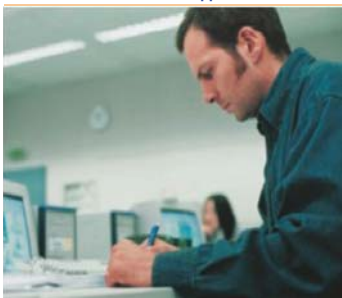

Competent consulting in technical questions covering a wide range of customer-oriented services for all our products and systems.

Note

Sirius Classic(Light Grey) is being phased-out and the successor is the Sirius Innovations (Dark Grey).

The Sirius Innovations' portfolio is currently available up to frame Size S2 and the rest of the sizes are to follow.

During this transition we will experience the colour mix as some products(Size S6-S12) will only receive a facelift and become dark grey instead of light grey, while the part number remains the same.

Sirius Classic

Sirius Innovations



LOW VOLTAGE POWER DISTRIBUTION

Sentron 3WL Circuit Breakers for System Protection, Fixed

Part Number	Rated I(A)	kA @ 400v	kA @ 525v
3WL1106-2_32-....	630	55	55
3WL1106-3_32-....	630	80	80
3WL1108-2_32-....	800	55	55
3WL1108-3_32-....	800	80	80
3WL1110-2_32-....	1000	55	55
3WL1110-3_32-....	1000	80	80
3WL1112-2_32-....	1250	55	55
3WL1112-3_32-....	1250	80	80
3WL1116-2_32-....	1600	55	55
3WL1116-3_32-....	1600	80	80
3WL1216-2_32-....	1600	55	55
3WL1216-3_32-....	1600	80	80
3WL1220-2_32-....	2000	55	55
3WL1220-3_32-....	2000	80	80
3WL1225-2_32-....	2500	55	55
3WL1225-3_32-....	2500	80	80
3WL1232-2_32-....	3200	55	55
3WL1232-3_32-....	3200	80	80

Horizontal
Connections



3WL1 Fixed ACB's

Electronic Trip Units

BB	ETU15B	LI	
CB	ETU25B	LSI	
EB	ETU45B	LSIN	
FB	ETU45B	LSIN	with Display
NB	ETU76B	LSIN	with Display
onic Trip Units with Ground Fault			
DG	ETU27B	LSING	
EG	ETU45B	LSING	
FG	ETU45B	LSING	with Display
NG	ETU76B	LSING	with Display

ETU Selection



Please enquire about 4 -poles ACB's



All trip units are Electronic

Technical Assistance :

<http://support.automation.siemens.com>

Share Call: 0860 80 80 80 (within RSA)

email: support.south-africa.automation@siemens.com

LOW VOLTAGE POWER DISTRIBUTION

Sentron 3WL Circuit Breakers for System Protection Withdrawable

Part Number	Rated I(A)	kA @ 400v	kA @ 525v
3WL1106-2_36-....	630	55	55
3WL1106-3_36-....	630	80	80
3WL1108-2_36-....	800	55	55
3WL1108-3_36-....	800	80	80
3WL1110-2_36-....	1000	55	55
3WL1110-3_36-....	1000	80	80
3WL1112-2_36-....	1250	55	55
3WL1112-3_36-....	1250	80	80
3WL1116-2_36-....	1600	55	55
3WL1116-3_36-....	1600	80	80
3WL1216-2_36-....	1600	55	55
3WL1216-3_36-....	1600	80	80
3WL1220-2_36-....	2000	55	55
3WL1220-3_36-....	2000	80	80
3WL1225-2_36-....	2500	55	55
3WL1225-3_36-....	2500	80	80
3WL1232-2_36-....	3200	55	55
3WL1232-3_36-....	3200	80	80
3WL1340-4_36-....	4000	100	100
3WL1350-4_36-....	5000	100	100

3WL1 Withdrawable Mount

Horizontal Connections



Electronic Trip Units

BB	ETU15B	LI	
CB	ETU25B	LSI	
EB	ETU45B	LSIN	
FB	ETU45B	LSIN	with Display
NB	ETU76B	LSIN	with Display

ETU Selection



Electronic Trip Units with Ground Fault

DG	ETU27B	LSING	
EG	ETU45B	LSING	
FG	ETU45B	LSING	with Display
NG	ETU76B	LSING	with Display

Please enquire about 4 -poles ACB's



All trip units are Electronic

LOW VOLTAGE POWER DISTRIBUTION

Sentron 3WL Circuit Breakers for System Add On Options

Options		-1 A A 2	Standard	
3WL.....	Voltage	1st Digit		
Closing Coil	110v	2	3WL1 Options	
Closing Coil	220v	3		
Motor + Closing Coil	220v	4		
Motor + Closing Coil	110v	5		
Motor + Closing Coil	20vdc	6		
1st Aux Trip unit		2nd Digit		
Shunt Trip Coil	24vdc	B		
Shunt Trip Coil	110v	F		
Shunt Trip Coil	220v	G		
2nd Aux Trip unit		3rd Digit		
Shunt Trip Coil	24vdc	B		
Shunt Trip Coil	110v	F		
Shunt Trip Coil	220v	G		
Undervoltage Coil	110v	R		
Undervoltage Coil	220v	S		
Undervoltage Coil	380-415v	T		
Auxiliary Switches		4th Digit		
Aux Contacts	4n/o 4n/c	4		
Aux Contacts	6n/o 2n/c	7		
Aux Contacts	5n/o 3n/c	8		

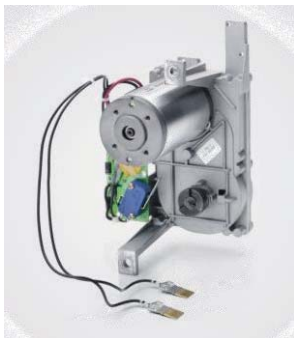

Motorized Mechanism



Technical Assistance :

<http://support.automation.siemens.com>

Share Call: 0860 80 80 80 (within RSA)

email: support.south-africa.automation@siemens.com

LOW VOLTAGE POWER DISTRIBUTION

Sentron 3WL Circuit Breakers Add On Options

Options 3WL.....-.....-Z		Add on +...	
Description		W/D	Fixed
Door Sealing Frame		T40	T40
Safety Shutters		R21	--
Mechanical Interlock		R55	S55
Profibus Interface		F02	F02
Position Indicators		R16	--
Castell Mounting Kit		S05	S05
	-Locks not Incl		
Padlock Mounting Kit		S07	S07
Ronis Lock		S08	S08
Ready to Close Aux		C22	C22
Tripped Signal Aux		K07	K07
Panel Door Interlock		R30	S30
Measurement Function Plus		F05	F05

3WL1 -Z Options



Ready to Close Indication
Unique to Siemens 3WL

Technical Assistance :
<http://support.automation.siemens.com>
 Share Call: 0860 80 80 80 (within RSA)
 email: support.south-africa.automation@siemens.com

LOW VOLTAGE POWER DISTRIBUTION

Sentron 3VA Circuit Breakers for Line Protection

Part Number	Rated I(A)
3VA1196-EE32-0AA0	11 ... 16
3VA1120-EE32-0AA0	14 ... 20
3VA1125-EE32-0AA0	18 ... 25
3VA1132-EE32-0AA0	22 ... 32
3VA1140-EE32-0AA0	28 ... 40
3VA1150-EE32-0AA0	35 ... 50
3VA1163-EE32-0AA0	44 ... 63
3VA1180-EE32-0AA0	56 ... 80
3VA1110-EE32-0AA0	70 ... 100



- ↑*3=Low breaking capacity N (25 kA at 415 V)
 *4=Standard breaking capacity S (36 kA at 415 V)
 *5=Medium breaking capacity M (55 kA at 415 V)
 *6=High breaking capacity H (70 kA at 415 V)

Part Number	Rated I(A)
3VA2025-HL32-0AA0	10 ... 25
3VA2040-HL32-0AA0	16 ... 40
3VA2063-HL32-0AA0	25 ... 63
3VA2010-HL32-0AA0	40 ... 100
3VA2116-HL32-0AA0	63 ... 160
3VA2225-HL32-0AA0	100 ... 250
3VA2340-HL32-0AA0	160 ... 400
3VA2463-HL32-0AA0	250 ... 630



- ↑5=Medium breaking capacity M (55 kA at 415 V)
 6=High breaking capacity H (85 kA at 415 V)
 7= Very High breaking capacity C (70 kA at 415 V)
 8= Extremely High breaking capacity L (150 kA at 415 V)

Sentron 3VA Isolators

Part Number	Rated I(A)	
3VA1163-1AA32-0AA0	63	3 pole
3VA1110-1AA32-0AA0	100	
3VA1112-1AA32-0AA0	125	
3VA1116-1AA32-0AA0	160	
3VA1163-1AA42-0AA0	63	4 pole
3VA1110-1AA42-0AA0	100	
3VA1112-1AA42-0AA0	125	
3VA1116-1AA42-0AA0	160	



Legend

EE	TM, LI function Adj thermal overcurrent, non-Adj short-circuit
HL	TM, LI function Adj thermal overcurrent, Adj short-circuit
AA	Without overcurrent, with non-adjustable short-circuit release

Technical Assistance :

<http://support.automation.siemens.com>

Share Call: 0860 80 80 80 (within RSA)

email: support.south-africa.automation@siemens.com

LOW VOLTAGE POWER DISTRIBUTION

Sentron 3VA Circuit Breakers Accessories

Undervoltage Coils

	Voltage
3VA9908-0BB11	24V DC
3VA9908-0BB14	110V DC
3VA9908-0BB15	220V DC
3VA9908-0BB16	250 V DC
3VA9908-0BB20	24 V AC
3VA9908-0BB23	110V AC
3VA9908-0BB25	220V AC

Shunt Trip Coils

	Voltage
3VA9988-0BL30	24V AC/DC
3VA9988-0BL32	110V AC/DC
3VA9988-0BL33	220V AC/DC
3VA9988-0BL20	380-600V AC

Auxilliary Contacts

3VA9988-0AA13	Single
3VA9988-0AA11	Double

Siemens Rotary Handle Mechanism

Part Number	MCCB
3VA9157-0FK21	3VA1 100-160A
3VA9267-0FK21	3VA2 100A-250A
3VA9467-0FK21	3VA2 400-630A

Siemens Rotary Handle Mechanism Illuminated

Part Number	MCCB
3VA9157-0FK23	3VA1 100-160A
3VA9267-0FK23	3VA2 100A-250A
3VA9467-0FK23	3VA2 400-630A



LOW VOLTAGE POWER DISTRIBUTION

Sentron 3VA Circuit Breakers Residual Current Devices

RCD Modules 3 Pole

Part Number	Current	MOUNTING	Voltage	
3VA9113-ORS20	160 A	Side(Left)	127 ... 480	3VA1
3VA9113-ORL20	160 A	Bottom	127 ... 480	
3VA9123-ORL30	160 A	Bottom	127 ... 690	3VA2
3VA9223-ORL30	250 A	Bottom	127 ... 690	
3VA9323-ORL30	400 A	Bottom	127 ... 690	
3VA9423-ORL30	630 A	Bottom	127 ... 690	



RCD Modules 4 Pole

Part Number	Current		Voltage	
3VA9114-ORS20	160 A	Side(Left)	127 ... 480	3VA1
3VA9114-ORL20	160 A	Bottom	127 ... 480	
3VA9124-ORL30	160 A	Bottom	127 ... 690	3VA2
3VA9224-ORL30	250 A	Bottom	127 ... 690	
3VA9324-ORL30	400 A	Bottom	127 ... 690	
3VA9424-ORL30	630 A	Bottom	127 ... 690	

3VA1

- Adjustable rated residual response current:

$I_n = 0.03 - 0.05 - 0.1 - 0.3 - 0.5 - 1 - 3 - 5 \text{ A}$,

- Adjustable delay time:

$t = 0 - 0.06 - 0.15 - 0.3 - 0.5 - 1 - 2 - 3 \text{ s}$

3VA2

- Adjustable rated residual response current:

$I_n = 0.03 - 0.05 - 0.1 - 0.3 - 0.5 - 1 - 3 - 5 - 10 - 30 \text{ A}$,

- Adjustable delay time

$t = 0 - 0.06 - 0.15 - 0.3 - 0.5 - 1 - 2 - 3 - 5 - 10 \text{ s}$

- Note: 30 A setting range only for type

AC applications



LOW VOLTAGE POWER DISTRIBUTION

Sentron 3VL Circuit Breakers For System Protection

Part Number	Rated I(A)
3VL1702-*DD33-0AA0	16 - 20
3VL1703-*DD33-0AA0	25 - 32
3VL1704-*DD33-0AA0	32 - 40
3VL1705-*DD33-0AA0	40 - 50
3VL1706-*DD33-0AA0	50 - 63
3VL1708-*DD33-0AA0	63 - 80
3VL1710-*DD33-0AA0	80 - 100
3VL1712-*DD33-0AA0	100 - 125
3VL1716-*DD33-0AA0	125 - 160

VL 160X



- ↑ * 1 = Standard Switching Capacity (55kA @ 400V; 18ka @ 525V)
 * 2 = High Breaking Capacity (70kA @ 400V; 30ka @ 525V)

Part Number	Rated I(A)
3VL2705-*DC33-0AA0	40 - 50
3VL2706-*DC33-0AA0	50 - 63
3VL2708-*DC33-0AA0	63 - 80
3VL2710-*DC33-0AA0	80 - 100
3VL2712-*DC33-0AA0	100 - 125
3VL2716-*DC33-0AA0	125 - 160
3VL3720-*DC36-0AA0	160 - 200
3VL3725-*DC36-0AA0	200 - 250
3VL4731-*DC36-0AA0	250 - 315
3VL4740-*DC36-0AA0	320 - 400
3VL5750-*DC36-0AA0	400 - 500
3VL5763-*DC36-0AA0	500 - 630

- ↑ * 1 = Standard Switching Capacity (55kA @ 400V; 25ka @ 525V)
 * 2 = High Breaking Capacity (70kA @ 400V; 40ka @ 525V)
 * 3 = Very High Breaking Capacity (100kA @ 400V; 50ka @ 525V)

Sentron 3VL Isolators

Part Number	Rated I(A)
3VL2710-*DE33-0AA0	100
3VL2716-*DE33-0AA0	160
3VL3725-*DE33-0AA0	250
3VL4740-*DE36-0AA0	400
3VL5763-*DE36-0AA0	630
3VL6780-*DE36-0AA0	800
3VL7712-*DE36-0AA0	1250
3VL8716-*DE30-0AA0	1600

- ↑ * 1 = Standard Switching Capacity (55kA @ 400V; 18ka @ 525V)
 * 2 = Standard Switching Capacity (70kA @ 400V; 30ka @ 525V)
 * 3 = Very High Breaking Capacity (100kA @ 400V; 50ka @ 525V)

Legend

- DD TM, LI function Adj thermal overcurrent, non-Adj short-circuit
 DC TM, LI function Adj thermal overcurrent, Adj short-circuit
 DE Without overcurrent, with non-adjustable short-circuit release

LOW VOLTAGE POWER DISTRIBUTION

Sentron 3VL Circuit Breakers For Motor Protection

Part Number	Rated I(A)
3VL2706-*DK33-0AA0	63
3VL2710-*DK33-0AA0	100
3VL2716-*DK33-0AA0	160
3VL3725-*DK36-0AA0	250
3VL4731-*DK36-0AA0	315
3VL5750-*DK36-0AA0	500



- ↑ * 1 = Standard Switching Capacity (55kA @ 400V; 25ka @ 525V)
* 2 = High Breaking Capacity (70kA @ 400V; 40ka @ 525V)
* 3 = Very High Breaking Capacity (100kA @ 400V; 50ka @ 525V)

	Rated I(A)
3VL2706-*SE36-0AA0	63
3VL2710-*SE36-0AA0	100
3VL2716-*SE36-0AA0	160
3VL3720-*SE36-0AA0	200
3VL3725-*SE36-0AA0	250
3VL4731-*SE36-0AA0	315
3VL4740-*SE36-0AA0	400
3VL5763-*SE36-0AA0	630
3VL6780-*SE36-0AA0	800
3VL7710-*SE36-0AA0	1000
3VL7712-*SE36-0AA0	1250
3VL8716-*SE30-0AA0	1600

- ↑ * 1 = Standard Switching Capacity (55kA @ 400V; 25ka @ 525V)
* 2 = High Breaking Capacity (70kA @ 400V; 40ka @ 525V)
* 3 = Very High Breaking Capacity (100kA @ 400V; 50ka @ 525V)

Legend

DK	Magnetic, I function Without overcurrent,with Adj short-circuit
SE	LSI,Adj overcurrent,non-Adj short-circuit-short-circuit delay

Technical Assistance :

<http://support.automation.siemens.com>

Share Call: 0860 80 80 80 (within RSA)

email: support.south-africa.automation@siemens.com

LOW VOLTAGE POWER DISTRIBUTION

Sentron 3VL Circuit Breakers Accessories

Undervoltage Coils	Voltage
3VL9400-1UG00	110V AC
3VL9400-1UH00	220V AC
3VL9400-1UJ00	400V AC
3VL9400-1UL00	525V AC
3VL9400-1UP00	24V DC
3VL9400-1UR00	110V DC
3VL9400-1US00	220V DC
Shunt Trip Coils	Voltage
3VL9400-1SR00	110V AC
3VL9400-1ST00	220V AC
3VL9400-1SV00	400-525V AC
3VL9400-1SC00	24V AC/DC
3VL9 400-1SK00	110V DC
3VL9 400-1SQ00	220V DC
Auxilliary Contacts	Comb
3VL9400-2AB00	1no/1nc
3VL9400-2AD00	1no/1nc/1as

3VL1-4



Undervoltage Coils	Voltage
3VL9800-1UG00	110V AC
3VL9800-1UH00	220V AC
3VL9800-1UJ00	400V AC
3VL9800-1UL00	525V AC
3VL9800-1UP00	24V DC
3VL9800-1UR00	110V DC
3VL9800-1US00	220V DC
Shunt Trip Coils	Voltage
3VL9800-1SR00	110V AC
3VL9800-1ST00	220V AC
3VL9800-1SV00	400-525V AC
3VL9800-1SC00	24V AC/DC
3VL9800-1SK00	110V DC
3VL9800-1SQ00	220V DC
Auxilliary Contacts	
3VL9800-2AC00	2no/2nc
3VL9800-2AE00	1no/1nc/1as

3VL5-8



Sentron 3VL Circuit Breakers Accessories

Siemens Rotary Handle Mechanism

Part Number	MCCB	siemens
3VL9300-3HF05	3VL1 - 3	
3VL9400-3HF05	3VL 4	
3VL9600-3HF05	3VL 5	
3VL9800-3HF05	3VL6 - 8	

3VL9200-9HF04	3VL1	Allbro
3VL9300-9HF04	3VL 2- 3	
3VL9400-9HF04	3VL 4	
3VL9600-9HF04	3VL5	

Aux fitted in Siemens Rotary mechanism

Part Number		MCCB
3VL9300-3AS10	1 CO	3VL1 - 3
3VL9300-3AT10	2 CO	3VL 1 - 3
3VL9400-3AS10	1 CO	3VL 4
3VL9400-3AT10	2 CO	3VL 4
3VL9600-3AS10	1 CO	3VL 5
3VL9600-3AT10	2 CO	3VL 5
3VL9800-3AS10	1 CO	3VL6 - 8
3VL9800-3AT10	2 CO	3VL6 - 8



Siemens Handle

Technical Assistance :

<http://support.automation.siemens.com>

Share Call: 0860 80 80 80 (within RSA)

email: support.south-africa.automation@siemens.com

LOW VOLTAGE POWER DISTRIBUTION

Sentron 3VL Circuit Breakers Residual Current Devices ONLY For TM, Starters, Disconnectors

RCD Modules 3 Pole

Part Number	Current	Voltage	1) 2)
3VL9112-5GA30(3VL1)	160	127-480v	
3VL9216-5GC30 (3VL2)	160	127-480v	
3VL9216-5GD30 (3VL2)	160	230-690v	
3VL9325-5GE30	250	127-480v	
3VL9325-5GF30	250	230-690v	

RCD Modules 4 Pole

Part Number	Current	Voltage
3VL9112-5GA40	160	127-480v
3VL9216-5GC40	160	127-480v
3VL9216-5GD40	160	230-690v
3VL9325-5GE40	250	127-480v
3VL9325-5GF40	250	230-690v
3VL9440-5GG40	400	127-480v
3VL9440-5GH40	400	230-690v



Adjustment

- 0.03
- 0.10
- 0.30
- 0.50
- 1.00
- 3.00

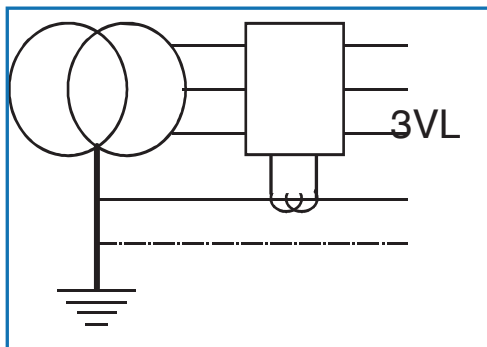
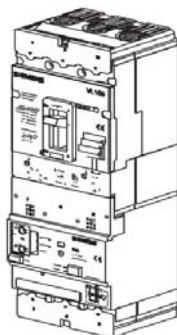

- 1) Only the right-hand accessory compartment and 4th-pole accessory compartment can be used for the installation of accessories,
- 2) VL160X (3VL1) + RCD module cannot be combined with motorized operating mechanism front operating mechanism door-coupling rotary operating mechanism locking device for toggle levers, screw terminal connections (3VL17...6-....) and Bowden wire interlocking.

SIRIUS - 3RV Moulded Case Circuit Breaker For Starter Protection 550V Type 2 Selection

Part Number Magnetics Only	Rated I(A)	In (A)	kA @ 400V	kA @ 690V
3RV1353-6BP10	1.6	21	85	10
3RV1353-6DP10	3.2	42	85	10
3RV1353-6MM10	32	192-384	85	10



3RV1363-7AN10	100	100-1000	120	70
3RV1363-7CN10	160	160-1600	120	70
3RV1363-7EN10	250	250-2500	120	70



3RV1364-7AN10	100	100-1000	120	80
3RV1364-7CN10	160	160-1600	120	80
3RV1364-7EN10	250	250-2500	120	80

3RV1373-7GN10	400	400-4000	120	70
3RV1373-7JN10	630	630-6300	120	70

3RV1383-7JN10	630	630-6300	100	30
3RV1383-7KN10	800	800-8000	100	30

Part Number ETU & Magnetic	Rated I(A)	In (A)	kA @ 550V	kA @ 690V
3RV1063-7AL10	40-100	600-1300	120	70
3RV1063-7CL10	64-160	960-2080	120	70
3RV1063-7DL10	80-200	1200-2600	120	70
3RV1073-7GL10	160-400	2400-5200	120	70
3RV1083-7JL10	252-630	3780-8190	100	30



Rotary operating handle mechanisms

3RV1956-0BA0 LOCAL OPER.MECHANISM WITH LOCK/DOOR INTERLOCKING FOR FRAME SIZE 3RV13 5

3RV1976-0BA0 LOCAL OPER.MECHANISM WITH LOCK/DOOR INTERLOCKING FOR FRAME SIZE 3RV1. 6, 7

3RV1986-0BA0 LOCAL OPER.MECHANISM WITH LOCK/DOOR INTERLOCKING FOR FRAME SIZE 3RV1. 8



Accessories for 3RV13 MCCB's

3RV1991-1AA0 AUX. SWITCH 250V AC/DC, 1C/O for 3RV1. 5, 6, 7, 8

3RV1991-1BA0 AUX. SWITCH 250V AC/DC, 3C/O for 3RV1. 5, 6, 7, 8

3RV1952-1ED0 SHUNT TRIP UNIT 110...127V AC, 110...125V DC FOR FRAME SIZE 3RV13 5

3RV1982-1ED0 SHUNT TRIP UNIT 110...127V AC, 110...125V DC FOR FRAME SIZE 3RV1. 6, 7, 8

3RV1952-1EF0 SHUNT TRIP UNIT 220...240V AC, 220...250V DC FOR FRAME SIZE 3RV13 5

3RV1982-1EF0 SHUNT TRIP UNIT 220...240V AC, 220...250V DC FOR FRAME SIZE 3RV1. 6, 7, 8



INDUSTRIAL CONTROLS

SIRIUS Innovations 3RV2 Motor Starter Protectors/ Circuit Breakers Up To 80A - Class 10 Thermal & Magnetic

Part Number	Rated I(A)	kA @ 400V	In	Size	
3RV2011-0AA10	0.11 - 0.16	100	2.1	SIZE S00	
3RV2011-0BA10	0.14 - 0.2	100	2.6		
3RV2011-0CA10	0.18 - 0.25	100	3.3		
3RV2011-0DA10	0.22 - 0.32	100	4.2		
3RV2011-0EA10	0.28 - 0.4	100	5.2		
3RV2011-0FA10	0.35 - 0.5	100	6.5		
3RV2011-0GA10	0.45 - 0.63	100	8.2		
3RV2011-0HA10	0.55 - 0.8	100	10		
3RV2011-0JA10	0.7 - 1	100	13		
3RV2011-0KA10	0.9 - 1.25	100	16		
3RV2011-1AA10	1.1 - 1.6	100	21		
3RV2011-1BA10	1.4 - 2	100	26		
3RV2011-1CA10	1.8 - 2.5	100	33		
3RV2011-1DA10	2.2 - 3.2	100	42		
3RV2011-1EA10	2.8 - 4	100	52		
3RV2011-1FA10	3.5 - 5	100	65		
3RV2011-1GA10	4.5 - 6.3	100	82		
3RV2011-1HA10	5.5 - 8	100	104		
3RV2011-1JA10	7 - 10	100	130		
3RV2011-1KA10	9 - 12.5	100	163		
3RV2011-4AA10	11 - 16	55	208	SIZE S0	
3RV2021-4AA10	11 - 16	55	208		
3RV2021-4BA10	14 - 20	55	260		
3RV2021-4CA10	17 - 22	55	286		
3RV2021-4DA10	20 - 25	55	325		
3RV2021-4NA10	23 - 28	55	364		
3RV2021-4EA10	27 - 32	55	400		
3RV2021-4PA10	23 - 28	20	432		
3RV2021-4FA10	34 - 40	20	480	SIZE S2	
3RV2031-4VA10	35 ... 45	65	650		
3RV2031-4WA10	42 ... 52	65	741		
3RV2031-4XA10	49 ... 59	65	845		
3RV2031-4JA10	54 ... 65	65	845		
3RV2031-4KA10	62 ... 73	65	949		
3RV2031-4RA10	70 ... 80	65	1040	SIZE S2	
Size S2, with increased switching capacity					
3RV2032-4VA10	35 ... 45	100			
3RV2032-4WA10	42 ... 52	100			
3RV2032-4XA10	35 ... 45	100			
3RV2032-4XA10	49 ... 59	100			
3RV2032-4JA10	54 ... 65	100			
3RV2032-4KA10	62 ... 73	100			
3RV2032-4RA10	70 ... 80	100			



3RV2011-0AA10



3RV2021-4AA10



3RV2032-4RA10

www.siemens.com/ie3ready

www.siemens.com/sirius

www.automation.siemens.com/SinaSave

INDUSTRIAL CONTROLS

SIRIUS Innovations 3RV2 Motor Starter Protectors/ Circuit Breakers Up To 80A - Class 10 Magnetic Only

Part Number	Rated I(A)	kA @ 400V	In	Size
3RV2311-0AC10	0.16	100	2.1	SIZE S00
3RV2311-0BC10	0.2	100	2.6	
3RV2311-0CC10	0.25	100	3.3	
3RV2311-0DC10	0.32	100	4.2	
3RV2311-0EC10	0.4	100	5.2	
3RV2311-0FC10	0.5	100	6.5	
3RV2311-0GC10	0.63	100	8.2	
3RV2311-0HC10	0.8	100	10	
3RV2311-0JC10	1	100	13	
3RV2311-0KC10	1.25	100	16	
3RV2311-1AC10	1.6	100	21	
3RV2311-1BC10	2	100	26	
3RV2311-1CC10	2.5	100	33	
3RV2311-1DC10	3.2	100	42	
3RV2311-1EC10	4	100	52	
3RV2311-1FC10	5	100	65	
3RV2311-1GC10	6.3	100	82	
3RV2311-1HC10	8	100	104	
3RV2311-1JC10	10	100	130	
3RV2311-1KC10	12.5	100	163	
3RV2311-4AC10	16	55	208	
3RV2321-4AC10	16	55	208	SIZE S0
3RV2321-4BC10	20	55	260	
3RV2321-4CC10	22	55	286	
3RV2321-4DC10	25	55	325	
3RV2321-4NC10	29	55	364	
3RV2321-4EC10	32	55	400	
3RV2321-4PC10	28	20	432	
3RV2321-4FC10	40	20	480	
3RV2331-4VC10	45	65	650	SIZE S2
3RV2331-4WC10	52	65	741	
3RV2331-4XC10	59	65	845	
3RV2331-4JC10	65	65	845	
3RV2331-4KC10	73	65	949	
3RV2331-4RC10	80	65	1040	
3RV2332-4VC10	45	100	650	SIZE S2
3RV2332-4WC10	52	100	741	
3RV2332-4XC10	59	100	845	
3RV2332-4JC10	65	100	845	
3RV2332-4KC10	73	100	949	
3RV2332-4RC10	80	100	1040	



3RV2311-4AC10



3RV2321-4AC10



3RV2331-4VC10

www.siemens.com/ie3ready

www.siemens.com/sirius

www.automation.siemens.com/SinaSave

INDUSTRIAL CONTROLS

SIRUIS Innovations 3RV2 Transformer Protectors - Thermal & Magnetic (20 X)

Part Number	Rated I(A)	kA @ 400V	In	Size
3RV2411-0AA10	0.11 - 0.16	100	3.3	SIZE S00
3RV2411-0BA10	0.14 - 0.2	100	4.2	
3RV2411-0CA10	0.18 - 0.25	100	5.2	
3RV2411-0DA10	0.22 - 0.32	100	6.5	
3RV2411-0EA10	0.28 - 0.4	100	8.2	
3RV2411-0FA10	0.35 - 0.5	100	10	
3RV2411-0GA10	0.45 - 0.63	100	13	
3RV2411-0HA10	0.55 - 0.8	100	16	
3RV2411-0JA10	0.7 - 1	100	21	
3RV2411-0KA10	0.9 - 1.25	100	26	
3RV2411-1AA10	1.1 - 1.6	100	33	
3RV2411-1BA10	1.4 - 2	100	42	
3RV2411-1CA10	1.8 - 2.5	100	52	
3RV2411-1DA10	2.2 - 3.2	100	65	
3RV2411-1EA10	2.8 - 4	100	82	
3RV2411-1FA10	3.5 - 5	100	104	
3RV2411-1GA10	4.5 - 6.3	100	130	
3RV2411-1HA10	5.5 - 8	100	163	
3RV2411-1JA10	7 - 10	100	208	
3RV2411-1KA10	9 - 12.5	100	260	
3RV2411-4AA10	11 - 16	55	286	



3RV2411-0AA10

3RV2421-4AA10	11 - 16	55	286	SIZE S0
3RV2421-4BA10	14 - 20	55	325	
3RV2421-4CA10	17 - 22	55	364	
3RV2421-4DA10	20 - 25	55	400	

3RV2431-4EA10	22 ... 32	65	656	SIZE S2
3RV2431-4UA10	32 ... 40	65	820	
3RV2431-4VA10	35 ... 45	65	922	
3RV2431-4WA10	42 ... 52	65	1025	
3RV2431-4XA10	49 ... 59	65	1040	
3RV2431-4JA10	54 ... 65	65	1040	



3RV2431-4WA10

3-phase busbars

For feeding several motor starter protectors with screw terminals, mounted side by side on standard mounting rails, insulated, with touch protection

 3RV1915-1AB	45 ³⁾	2	--	--	63	S00, S0 ²⁾	▶▶▶	3RV1915-1AB
		3	--	--	63	S00, S0 ²⁾	▶▶▶	3RV1915-1BB
		4	--	--	63	S00, S0 ²⁾	▶▶▶	3RV1915-1CB
		5	--	--	63	S00, S0 ²⁾	▶▶▶	3RV1915-1DB
 3RV1915-1BB	55 ⁴⁾	--	2	--	63	S00, S0 ²⁾	▶▶▶	3RV1915-2AB
		--	3	--	63	S00, S0 ²⁾	▶▶▶	3RV1915-2BB
		--	4	--	63	S00, S0 ²⁾	▶▶▶	3RV1915-2CB
 3RV1915-1CB		2	--	--	108	S2	▶▶▶	3RV1935-1A
		3	--	--	108	S2	▶▶▶	3RV1935-1B
		4	--	--	108	S2	▶▶▶	3RV1935-1C
 3RV1915-1DB	63 ⁵⁾	--	--	2	63	S00, S0 ²⁾	▶▶▶	3RV1915-3AB
		--	--	4	63	S00, S0 ²⁾	▶▶▶	3RV1915-3CB
		75 ⁵⁾	--	2	2	108	S2	▶▶▶
		--	3	3	108	S2	▶▶▶	3RV1935-3B
		--	4	4	108	S2	▶▶▶	3RV1935-3C

3-phase line side terminal

Three-phase infeed terminals							
 3RV2925-5AB	Connection from top						
	2.5 ... 25 (2.5 ... 50) ¹⁾	2.5 ... 16 (2.5 ... 35) ¹⁾	10 ... 4 (10 ... 1/0) ¹⁾	3 ... 4 (4 ... 6)	S00, S0	▶	3RV2925-5AB
 3RV2935-5A	1 x (2.5 ... 70) ¹⁾	1 x (2.5 ... 50) ¹⁾	1 x (10 ... 2/0) ¹⁾	2 x 4 ... 6	S2	▶	3RV2935-5A

SIRIUS Innovations 3RV2 Accessories

Part Number	Description	Frame Size	
Rotary operating mechanism			
3RV1921-1B	Allbro handle mechanism (Local)	S00 & S0	
3RV1931-1B	Allbro handle mechanism (Local)	S2	
3RV2926-0B	Handle and 130mm shaft - German design	S00 ... S2	
3RV2926-0K	Handle and 330mm shaft - German design	S00 ... S2	
3RV2926-2B	Complete rotary handle mechanism. German Design, Gray with 300mm long shaft	S00, S0	
3RV2926-2C	Complete rotary handle mechanism. German Design, Yellow & Red with 300mm long shaft	S00 & S0	
3RV2936-2B	Complete rotary handle mechanism. German Design, Gray with 300mm long shaft	S2	
3RV2936-2C	Complete rotary handle mechanism. German Design, Yellow & Red with 300mm long shaft	S2	
Lateral auxiliary switches			
3RV2901-1A	1NO+1NC	S00...S2	
3RV2901-1B	2NO		
3RV2901-1C	2NC		
3RV2901-1J	2NO+2NC		
Transverse auxiliary switches			
3RV2901-1D	1 CO	S00.. .S2	
3RV2901-1E	1NO+1NC		
3RV2901-1F	2NO		
Signal switch (tripped & short circuit)			
3RV2921-1M	1NO + 1NC	S00...S2	
Isolator Modules			
3RV2928-1A	Locable isolator module	S00 - S0	
3RV2938-1A	Locable isolator module	S2	
Undervoltage trip release			
3RV2902-1AB4	24V DC	S00...S2	
3RV2902-1AF0	110V AC		
3RV2902-1AP0	230V AC		
3RV2902-1AV0	400V AC		
3RV2902-1AS0	500V AC		
Shunt trips release			
3RV2902-1DB0	24 V AC	S00...S2	
3RV2902-1DF0	110 V AC		
3RV2902-1DP0	220 V AC		
3RV2902-1DV0	380 V AC		
3RV2902-1DS0	500 V AC		

SIRIUS Innovations 3RV2 Accessories

Part Number

Description

Link modules between 3RV2 MSP & 3RT2 contactors with screw terminals

3RA1921-1DA00	Link module between S00 3RV2 and S00 3RT2 AC/DC - Single Units
3RA2921-1AA00	Link module between S00/S0 3RV2 and S0 3RT2 AC Only - Single Units
3RA2921-1BA00	Link module between S00/S0 3RV2 and S00 3RT2 DC Only - Single Units
3RA2931-1AA00	Link module between S2 3RV2 and S2 3RT2 AC/DC Only - Single Units
3RA1921-1D	Link module between S00 3RV2 and S00 3RT2 AC/DC - Packs of 10
3RA2921-1A	Link module between S00/S0 3RV2 and S0 3RT2 AC Only - Packs of 10
3RA2921-1B	Link module between S00/S0 3RV2 and S00 3RT2 DC Only - Packs of 10
3RA2931-1A	Link module between S2 3RV2 and S2 3RT2 AC/DC Only - Packs of 10



3RA2921-1AA00



3RA2931-1AA00

Molded-plastic enclosures for surface mounting 3RV2

3RV1923-1CA00	Moulded Plastic, IP55 enclosure with N & PE terminals - Size S00 & S0, 54mm wide
3RV1923-1DA00	Moulded Plastic, IP55 enclosure with N & PE terminals - Size S00 & S0, 72mm wide
3RV1933-1DA00	Moulded Plastic, IP55 enclosure with N & PE terminals - Size 2, 82mm wide
3RV1923-1FA00	Moulded Plastic, IP55 enclosure with N & PE terminals - Size S00 & S0, 54mm wide, yellow & red handle
3RV1923-1GA00	Moulded Plastic, IP55 enclosure with N & PE terminals - Size S00 & S0, 72mm wide, yellow & red handle
3RV1933-1GA00	Moulded Plastic, IP55 enclosure with N & PE terminals - Size S2, 82mm wide, yellow & red handle



3RV1923-1DA00



3RV1923-1FA00,
3RV1933-1GA00

Cast aluminum enclosures for surface mounting 3RV2

3RV1923-1DA01	Cast aluminum, IP65 enclosure with PE terminal - Size S00 & S0, 54mm wide
3RV1923-1GA01	Cast aluminum, IP65 enclosure with PE terminal - Size S00 & S0, 72mm wide



3RV1923-1DA01

www.siemens.com/ie3ready

www.siemens.com/sirius

www.automation.siemens.com/SinaSave

Please use below contact information should you require further assistance

Technical Assistance :

<http://support.automation.siemens.com>

Share Call: 0860 80 80 80 (within RSA)

email: support.south-africa.automation@siemens.com

INDUSTRIAL CONTROLS

SIRIUS Classic 3RV1 Size S3 Motor Starter Protectors / Circuit Breakers Up To 100A - Class 10

Part Number	Rated I(A)	kA @ 400V	In	Size
For Motor Protection				
3RV1041-4FA10	28-40	50	520	SIZE 3
3RV1041-4HA10	36-50	50	650	
3RV1041-4JA10	45-63	50	819	
3RV1041-4KA10	57-75	50	975	
3RV1041-4LA10	70-90	50	1170	
3RV1041-4MA10	80-100	50	1235	

3RV1042...
Available



3RV1041-4LA10

For starter combinations				
3RV1341-4FC10	40	100	520	SIZE S3
3RV1341-4HC10	50	100	650	
3RV1341-4JC10	63	100	819	
3RV1341-4KC10	75	100	975	
3RV1341-4LC10	90	100	1170	
3RV1341-4MC10	100	100	1235	

3RV1342...
Available

Lateral auxiliary switches				
3RV1901-1A		1NO+1NC		SIZE S3
3RV1901-1B		2NO		
3RV1901-1C		2NC		
3RV1901-1J		2NO+2NC		



3RV1901-1A

Transverse auxiliary switches				
3RV1901-1D		1 CO		SIZE S3
3RV1901-1E		1NO+1NC		
3RV1901-1F		2NO		



3RV1901-1E

Signal switch (tripped & short circuit)				
3RV1921-1M		1NO + 1NC		S3

Undervoltage trip units				
3RV1902-1AB4		24V DC		SIZE S3
3RV1902-1AF0		110V AC		
3RV1902-1AP0		230V AC		
3RV1902-1AV0		400V AC		

Shunt trips				
3RV1902-1DB0		24 V AC		SIZE S3
3RV1902-1DF0		110 V AC		
3RV1902-1DP0		220 V AC		
3RV1902-1DV0		380 V AC		
3RV1902-1DS0		500 V AC		



3RV1902-1DP0

Rotary operating mechanism				
3RV1941-1B		Allbro Handle		S3
3RV2946-2B		Complete rotary handle mechanism. German Design, Gray with 300mm long		S3



3RV2946-2B

INDUSTRIAL CONTROLS

SIRIUS Classic 3RV1 Circuit Breakers - SO, S2 & S3 Up To 100A

Part Number Rated I(A) kA @ 400V In Size

For Motor Protection

3RV1011-0AA10	0.11-0.16	100	100	
3RV1011-0BA10	0.14-0.2	100	100	
3RV1011-0CA10	0.18-0.25	100	100	
3RV1011-0DA10	0.22-0.32	100	100	
3RV1011-0EA10	0.28-0.4	100	100	
3RV1011-0FA10	0.35-0.5	100	100	
3RV1011-0GA10	0.45-0.63	100	100	
3RV1011-0HA10	0.55-0.8	100	100	
3RV1011-0JA10	0.7-1	100	100	
3RV1011-0KA10	0.9-1.25	100	100	
3RV1011-1AA10	1.1-1.6	100	100	
3RV1011-1BA10	1.4-2	100	10	
3RV1011-1CA10	1.8-2.5	100	10	
3RV1011-1DA10	2.2-3.2	100	3	
3RV1011-1EA10	2.8-4	100	3	
3RV1011-1FA10	3.5-5	100	3	
3RV1011-1GA10	4.5-6.3	100	3	
3RV1011-1HA10	5.5-8	50	3	
3RV1011-1JA10	7-10	50	3	
3RV1011-1KA10	9-12	50	3	



3RV1011-0JA10

SIZE S00

3RV1021-0AA10	0.11-0.16	100	100	
3RV1021-0BA10	0.14-0.2	100	100	
3RV1021-0CA10	0.18-0.25	100	100	
3RV1021-0DA10	0.22-0.32	100	100	
3RV1021-0EA10	0.28-0.4	100	100	
3RV1021-0FA10	0.35-0.5	100	100	
3RV1021-0GA10	0.45-0.63	100	100	
3RV1021-0HA10	0.55-0.8	100	100	
3RV1021-0JA10	0.7-1	100	100	
3RV1021-0KA10	0.9-1.25	100	100	
3RV1021-1AA10	1.1-1.6	100	100	
3RV1021-1BA10	1.4-2	100	100	
3RV1021-1CA10	1.8-2.5	100	100	
3RV1021-1DA10	2.2-3.2	100	100	
3RV1021-1EA10	2.8-4	100	100	
3RV1021-1FA10	3.5-5	100	100	
3RV1021-1GA10	4.5-6.3	100	100	
3RV1021-1HA10	5.5-8	100	42	
3RV1021-1JA10	7-10	100	42	
3RV1021-1KA10	9-12.5	100	42	
3RV1021-4AA10	11-16	100	10	
3RV1021-4BA10	14-20	50	10	
3RV1021-4CA10	17-22	50	10	
3RV1021-4DA10	20-25	50	10	



3RV1021-0JA10

SIZE S0









INDUSTRIAL CONTROLS

SIRIUS Classic 3RV1 Circuit Breakers - SO, S2 & S3 Up To 100A

Part Number	Rated I(A)	kA @ 400V	In	Size
3RV1031-4AA10	11-16	50	12	SIZE S2
3RV1031-4BA10	14-20	50	12	
3RV1031-4DA10	18-25	50	12	
3RV1031-4EA10	22-32	50	10	
3RV1031-4FA10	28-40	50	10	
3RV1031-4GA10	36-45	50	10	
3RV1031-4HA10	40-50	50	10	
3RV1041-4FA10	28-40	50	12	SIZE 3
3RV1041-4HA10	36-50	50	12	
3RV1041-4JA10	45-63	50	12	
3RV1041-4KA10	57-75	50	8	
3RV1041-4LA10	70-90	50	8	
3RV1041-4MA10	80-100	50	8	
For starter combinations				
3RV1321-0JC10	1	100	-	SIZE S0
3RV1321-0KC10	1.25	100	-	
3RV1321-1AC10	1.6	100	-	
3RV1321-1BC10	2	100	-	
3RV1321-1CC10	2.5	100	-	
3RV1321-1DC10	3.2	100	-	
3RV1321-1EC10	4	100	-	
3RV1321-1FC10	5	100	-	
3RV1321-1GC10	6.3	100	-	
3RV1321-1HC10	8	100	100	
3RV1321-1JC10	10	100	100	
3RV1321-1KC10	12.5	100	100	
3RV1321-4AC10	16	50	100	
3RV1321-4BC10	20	50	100	
3RV1321-4CC10	22	50	100	
3RV1321-4DC10	25	50	100	
3RV1331-4AC10	16	50	100	SIZE S2
3RV1331-4BC10	20	50	100	
3RV1331-4DC10	25	50	100	
3RV1331-4EC10	32	50	100	
3RV1331-4FC10	40	50	100	
3RV1331-4GC10	45	50	100	
3RV1331-4HC10	50	50	100	
3RV1341-4FC10	40	100	100	SIZE S3
3RV1341-4HC10	50	100	100	
3RV1341-4JC10	63	100	100	
3RV1341-4KC10	75	100	100	
3RV1341-4LC10	90	100	100	
3RV1341-4MC10	100	100	100	





INDUSTRIAL CONTROLS

SIRIUS Classic SIRIUS 3RV1 Circuit Breakers - Accessories

Part Number	Description	Details	
Lateral auxiliary switches			
3RV1901-1A	1NO+1NC	SIZE S00-S3	
3RV1901-1B	2NO		
3RV1901-1C	2NC		
3RV1901-1J	2NO+2NC		
Transverse auxiliary switches			
3RV1901-1D	1 CO	SIZE S00-S3	
3RV1901-1E	1NO+1NC		
3RV1901-1F	2NO		
Signal switch (tripped & short circuit)			
3RV1921-1M	1NO + 1NC	S0-S3	
Undervoltage trip units			
3RV1902-1AB4	24V DC	SIZE S00-S3	
3RV1902-1AF0	110V AC		
3RV1902-1AP0	230V AC		
3RV1902-1AV0	400V AC		
Shunt trips			
3RV1902-1DB0	24 V AC	SIZE S00-S3	
3RV1902-1DF0	110 V AC		
3RV1902-1DP0	220 V AC		
3RV1902-1DV0	380 V AC		
3RV1902-1DS0	500 V AC		
3-phase busbars			
3RV1915-1AB	2 breakers, modular spacing 45mm	SIZE S00-S0	
3RV1915-1BB	3 breakers, modular spacing 45mm		
3RV1915-1CB	4 breakers, modular spacing 45mm		
3RV1915-1DB	5 breakers, modular spacing 45mm		
3RV1915-3AB	2 breakers, modular spacing 63mm		
3RV1915-3CB	4 breakers, modular spacing 63mm		
3-phase line side terminal			
3RV1915-5A	top connection	SIZE S00-S0	
3RV1915-5B	bottom connection		
3RV1915-5B	Cover for tags		
Rotary operating mechanism			
3RV1921-1B	Allbro Handle	S0	
3RV1931-1B	Allbro Handle	S2	
3RV1941-1B	Allbro Handle	S3	
3RV2926-2B	Door coupling oper. Mech.	S0	
3RV2936-2B	Door coupling oper. Mech.	S2	
3RV2946-2B	Door coupling oper. Mech.	S3	

LOW VOLTAGE POWER DISTRIBUTION

Miniature Circuit Breakers (MCB's) Type 5SY-15kA, C Curve

Part Number	Details	Rated Current	
5SY7101-7CC	Single pole	1	
5SY7102-7CC		2	
5SY7104-7CC		4	
5SY7106-7CC		6	
5SY7110-7CC		10	
5SY7116-7CC		16	
5SY7120-7CC		20	
5SY7125-7CC		25	
5SY7132-7CC		32	
5SY7140-7CC		40	
5SY7150-7CC		50	
5SY7163-7CC		63	
5SY7501-7CC	Single pole+N	1	
5SY7502-7CC		2	
5SY7504-7CC		4	
5SY7506-7CC		6	
5SY7510-7CC		10	
5SY7516-7CC		16	
5SY7520-7CC		20	
5SY7525-7CC		25	
5SY7532-7CC		32	
5SY7540-7CC		40	
5SY7550-7CC		50	
5SY7563-7CC	63		
5SY7201-7CC	Double pole	1	
5SY7202-7CC		2	
5SY7204-7CC		4	
5SY7206-7CC		6	
5SY7210-7CC		10	
5SY7216-7CC		16	
5SY7220-7CC		20	
5SY7225-7CC		25	
5SY7232-7CC		32	
5SY7240-7CC		40	
5SY7250-7CC		50	
5SY7263-7CC		63	
5SY7301-7CC	Triple pole	1	
5SY7302-7CC		2	
5SY7304-7CC		4	
5SY7306-7CC		6	
5SY7310-7CC		10	
5SY7316-7CC		16	
5SY7320-7CC		20	
5SY7325-7CC		25	
5SY7332-7CC		32	
5SY7340-7CC		40	
5SY7350-7CC		50	
5SY7363-7CC		63	

LOW VOLTAGE POWER DISTRIBUTION

Miniature Circuit Breakers (MCB's): Type 5SY - 15kA, C Curve

Part Number	Details	Rated Current
5SY7401-7CC	Four pole	1
5SY7402-7CC		2
5SY7404-7CC		4
5SY7406-7CC		6
5SY7410-7CC		10
5SY7416-7CC		16
5SY7420-7CC		20
5SY7425-7CC		25
5SY7432-7CC		32
5SY7440-7CC		40
5SY7450-7CC		50
5SY7463-7CC		63
220VDC 10kA		
5SY5101-7CC	Single pole	1
5SY5102-7CC		2
5SY5104-7CC		4
5SY5106-7CC		6
5SY5110-7CC		10
5SY5116-7CC		16
5SY5120-7CC		20
5SY5125-7CC		25
5SY5132-7CC		32
5SY5140-7CC		40
5SY5150-7CC		50
5SY5163-7CC		63
5SY5201-7CC	Double pole	1
5SY5202-7CC		2
5SY5204-7CC		4
5SY5206-7CC		6
5SY5210-7CC		10
5SY5216-7CC		16
5SY5220-7CC		20
5SY5225-7CC		25
5SY5232-7CC		32
5SY5240-7CC		40
5SY5250-7CC		50
5SY5263-7CC		63
Accessories		
5ST3030	AC110-415V Shunt trip	
5ST3010	1NO+1NC Aux sw.	
5ST3801	locking device	
5ST3011	2NC Aux sw.	
5ST3814-0CC	Handle Mechanism	



LOW VOLTAGE POWER DISTRIBUTION

Residual Current Circuit Breakers (RCCB's) Type 5SV

Part Number I (mA) I (A) MW

Two Pole

5SV4111-0	10	16	2
5SV4312-0	30	25	2
5SV4314-0		40	
5SV4412-0	100	25	2
5SV4414-0		40	
5SV4612-0	300	25	2
5SV4614-0		40	



Two Pole

5SV4316-0	30	63	3
5SV4317-0		80	
5SV4416-0	100	63	2,5
5SV4417-0		80	
5SV4616-0	300	63	2,5
5SV4617-0		80	



Four Pole

5SV4342-0	30	25	4
5SV4344-0		40	
5SV4346-0		63	
5SV4442-0	100	25	4
5SV4444-0		40	
5SV4446-0		63	
5SV4642-0	300	25	4
5SV4644-0		40	
5SV4646-0		63	



Block

5SW3300			1NO + 1NC
---------	--	--	-----------



Technical Assistance :

<http://support.automation.siemens.com>

Share Call: 0860 80 80 80 (within RSA)

email: support.south-africa.automation@siemens.com

LOW VOLTAGE POWER DISTRIBUTION

Sentron Switching Devices and Switch Disconnectors

Part Number	Rated I(A)	
3LD 3 Pole 4 Hole mounting		
3LD2003-0TK__	16	
3LD2103-0TK__	25	
3LD2203-0TK__	32	
3LD2504-0TK__	63	
3LD2704-0TK__	100	
3LD2804-0TK__	125	
Actuators ↑		
Black	51	
Red/Yellow	53	
3LD		
3LD 3+N Pole 4 Hole mounting		
3LD2003-1TL__	16	
3LD2103-1TL__	25	
3LD2203-1TL__	32	
3LD2504-1TL__	63	
3LD2704-0TK__	100	+3LD9280-0B
3LD2804-0TK__	125	+3LD9280-0B
Actuators ↑		
Black	51	
Red/Yellow	53	



Part Number	Rated I(A)	Fuse Size
3NP1 3Pole		
3NP1133-1CA10	160	000 - 00
3NP1143-1DA10	250	0 - 1
3NP1153-1DA10	400	1 - 2
3NP1163-1DA10	630	2 - 3
3NP1		



3KD Switch Disconnectors Up To 1600 A

Part Number	Rated I(A)		Size
3KD Basic units without handle, front operating mechanisms			
3 POLES		4 POLES	
3KD1630-2ME10-0	16	3KD1640-2ME10-0	1
3KD2230-2ME10-0	32	3KD2240-2ME10-0	1
3KD2630-2ME10-0	63	3KD2640-2ME10-0	1
3KD2830-2NE10-0	80	3KD2840-2NE10-0	2
3KD3030-2NE10-0	100	3KD3040-2NE10-0	2
3KD3230-2NE10-0	125	3KD3240-2NE10-0	2
3KD3430-2NE10-0	160	3KD3440-2NE10-0	2
3KD3630-0NE10-0	200	3KD3640-0NE10-0	2
3KD3830-0PE10-0	250	3KD3840-0PE10-0	3
3KD4030-0PE10-0	315	3KD4040-0PE10-0	3
3KD4230-0PE10-0	400	3KD4240-0PE10-0	3
3KD4430-0QE10-0	500	3KD4440-0QE10-0	4
3KD4630-0QE10-0	630	3KD4640-0QE10-0	4
3KD4830-0QE10-0	800	3KD4840-0QE10-0	4
3KD5030-0RE10-0	1000	3KD5040-0RE10-0	5
3KD5230-0RE10-0	1250	3KD5240-0RE10-0	5
3KD5430-0RE10-0	1600	3KD5440-0RE10-0	5

3KD Complete assemblies with direct operating mechanism Gray

3 POLES		4 POLES	
3KD1632-2ME10-0	16	3KD1642-2ME10-0	1
3KD2232-2ME10-0	32	3KD2242-2ME10-0	1
3KD2632-2ME10-0	63	3KD2642-2ME10-0	1
3KD2832-2NE10-0	80	3KD2842-2NE10-0	2
3KD3032-2NE10-0	100	3KD3042-2NE10-0	2
3KD3232-2NE10-0	125	3KD3242-2NE10-0	2
3KD3432-2NE10-0	160	3KD3442-2NE10-0	2
3KD3632-0NE10-0	200	3KD3642-0NE10-0	2
3KD3832-0PE10-0	250	3KD3842-0PE10-0	3
3KD4032-0PE10-0	315	3KD4042-0PE10-0	3
3KD4232-0PE10-0	400	3KD4242-0PE10-0	3
3KD4432-0QE10-0	500	3KD4442-0QE10-0	4
3KD4632-0QE10-0	630	3KD4642-0QE10-0	4
3KD4832-0QE10-0	800	3KD4842-0QE10-0	4
3KD5032-0RE10-0	1000	3KD5042-0RE10-0	5
3KD5232-0RE10-0	1250	3KD5242-0RE10-0	5
3KD5432-0RE10-0	1600	3KD5442-0RE10-0	5

Accessories and spare parts

Door-coupling rotary operating mechanisms

Gray	Sizes	Red/yellow
3KD9115-1	for size 1; 3KD.....M	3KD9115-2
3KD9215-1	for size 2; 3KD.....N	3KD9215-2
3KD9315-1	for size 3; 3KD.....P	3KD9315-2
3KD9415-1	for size 4; 3KD.....Q	3KD9415-2
3KD9515-1	for size 5; 3KD.....R	3KD9515-2

Auxiliary switches

3KD9103-5	Auxiliary switch module for 3KD9103-1
3KD9103-1	Auxiliary switch for sizes 1 and 2, 1CO
3SB3400-0A	Auxiliary switch for sizes 3 to 5, 1NO/1NC

Sentron Switching Devices and Switch Disconnectors Accessories

Part Number	Rated I(A)	Fuse Size
3KL 3 Pole Basic version without Handle		
3KL5030-1AB01	63	000 - 00
3KL5230-1AB01	125	000 - 00
3KL5330-1AB01	160	000 - 00
3KL5530-1AB01	250	1 - 2
3KL5730-1AB01	400	1 - 2
3KL6130-1AB02	630	2 - 3
3KL6230-1AB02	800	2 - 3
3KL 4 Pole Basic version without Handle		
3KL5040-1AB01	63	000 - 00
3KL5240-1AB01	125	000 - 00
3KL5340-1AB01	160	000 - 00
3KL5540-1AB01	250	1 - 2
3KL5740-1AB01	400	1 - 2
3KL6140-1AB00	630	2 - 3
3KL 3 Pole Basic version with 8UC Handle		
3KL5030-1GB01	63	000 - 00
3KL5230-1GB01	125	000 - 00
3KL5330-1GB01	160	000 - 00
3KL5530-1GB01	250	1 - 2
3KL5730-1GB01	400	1 - 2
3KL6130-1GB02	630	2 - 3
3KL6230-1GB02	800	2 - 3
3KL 4 Pole Basic version with 8UC Handle		
3KL5040-1GB01	63	000 - 00
3KL5240-1GB01	125	000 - 00
3KL5340-1GB01	160	000 - 00
3KL5540-1GB01	250	1 - 2
3KL5740-1GB01	400	1 - 2
3KL6140-1GB02	630	2 - 3



LOW VOLTAGE POWER DISTRIBUTION

Sentron Switching Devices and Switch Disconnectors Accessories

Part Number	Description	
3LD9200-2B	N or PE terminal	3LD
3LD9200-5B	Auxiliary contacts 1no/1nc	
3LD9224-1B	Rotary Handle Black Padlockable	
3LD9224-3B	Rotary Handle Red/Yellow Padlockable	
3LD9220-0C	4th Contact Neutral	

Part Number	Description	
3NP1920-1FA00	Auxiliary contact 1co	3NP1
3NP1923-1DA00	Door Cover	
3NP1923-1CF00	Door Cover Support	

Part Number	Description		
3KL5030			
3KX3507-0AA01	Fuse Partitions	3KL	
8UC7111-1BB10	Lockable handle with shaft(300mm)		
3SB1400-0A	Auxiliary Contacts 1no/1nc		
3KL5040/3KL52/3KL53			
3KX3507-0AA01	Fuse Partitions		
8UC7212-1BB20	Lockable handle with shaft(300mm)		
3SB1400-0A	Auxiliary Contacts 1no/1nc		
3KL55/3KL57			
3KX3557-0AA01	Fuse Partitions		
8UC7313-1BB30	Lockable handle with shaft(300mm)		
3SB1400-0A	Auxiliary Contacts 1no/1nc		
3KL61/3KL62			
8UC7414-1BB44	Lockable handle with shaft(300mm)		
8UC9253	Shaft Coupling		
3KX3612-1B	Auxiliary Contacts 1no/1nc		

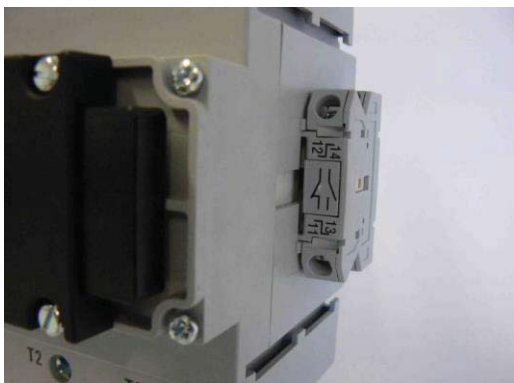

LOW VOLTAGE POWER DISTRIBUTION

HRC - Fuses

Part Number **Description** **Size** **Current (I)**

gL/gG - cable & line protection. 500V AC / 440V DC (S000 250VDC)

3NA3801	HRC Fuse Link	000	6
3NA3803	HRC Fuse Link	000	10
3NA3805	HRC Fuse Link	000	16
3NA3807	HRC Fuse Link	000	20
3NA3810	HRC Fuse Link	000	25
3NA3812	HRC Fuse Link	000	32
3NA3814	HRC Fuse Link	000	35
3NA3817	HRC Fuse Link	000	40
3NA3820	HRC Fuse Link	000	50
3NA3822	HRC Fuse Link	000	63
3NA3824	HRC Fuse Link	000	80
3NA3830	HRC Fuse Link	000	100
3NA3832	HRC Fuse Link	00	125
3NA3836	HRC Fuse Link	00	160



gL/gG - cable & line protection. 690V AC / 440V DC (S000)

3NA3801-6	HRC Fuse Link	000	6
3NA3803-6	HRC Fuse Link	000	10
3NA3805-6	HRC Fuse Link	000	16
3NA3807-6	HRC Fuse Link	000	20
3NA3810-6	HRC Fuse Link	000	25
3NA3812-6	HRC Fuse Link	000	32
3NA3814-6	HRC Fuse Link	000	35
3NA3820-6	HRC Fuse Link	000	50
3NA3822-6	HRC Fuse Link	00	63
3NA3824-6	HRC Fuse Link	00	80
3NA3830-6	HRC Fuse Link	00	100



LOW VOLTAGE POWER DISTRIBUTION

HRC - Fuses

Part Number	Description	Size	Current (I)
gL/gG - cable & line protection. 500V AC / 440V DC			
3NA3110	HRC Fuse Link	1	25
3NA3120	HRC Fuse Link	1	50
3NA3122	HRC Fuse Link	1	63
3NA3130	HRC Fuse Link	1	100
3NA3132	HRC Fuse Link	1	125
3NA3136	HRC Fuse Link	1	160
3NA3140	HRC Fuse Link	1	200
3NA3142	HRC Fuse Link	1	224
3NA3144	HRC Fuse Link	1	250
3NA3244	HRC Fuse Link	2	250
3NA3250	HRC Fuse Link	2	300
3NA3252	HRC Fuse Link	2	315
3NA3254	HRC Fuse Link	2	355
3NA3260	HRC Fuse Link	2	400
3NA3354	HRC Fuse Link	3	355
3NA3360	HRC Fuse Link	3	400
3NA3360	HRC Fuse Link	3	400
3NA3365	HRC Fuse Link	3	500
3NA3372	HRC Fuse Link	3	630
3NA3475	HRC Fuse Link	4	800
3NA3480	HRC Fuse Link	4	1000



Sitor - Semiconductor Fuses

Part Number	Description	Size	Current (I)
-------------	-------------	------	-------------

gS - Semiconductir protection. 690V AC

3NE1813-0	Sitor Fuse Link	000	16
3NE1814-0	Sitor Fuse Link	000	20
3NE1815-0	Sitor Fuse Link	000	25
3NE1803-0	Sitor Fuse Link	000	35
3NE1802-0	Sitor Fuse Link	000	40
3NE1817-0	Sitor Fuse Link	000	50
3NE1818-0	Sitor Fuse Link	000	63
3NE1820-0	Sitor Fuse Link	000	80
3NE1021-0	Sitor Fuse Link	00	100
3NE1022-0	Sitor Fuse Link	00	125
3NE1224-0	Sitor Fuse Link	1	160
3NE1225-0	Sitor Fuse Link	1	200
3NE1227-0	Sitor Fuse Link	1	250
3NE1230-0	Sitor Fuse Link	1	315
3NE1331-0	Sitor Fuse Link	2	350
3NE1332-0	Sitor Fuse Link	2	400
3NE1333-0	Sitor Fuse Link	2	450
3NE1334-0	Sitor Fuse Link	2	500
3NE1435-0	Sitor Fuse Link	3	560
3NE1436-0	Sitor Fuse Link	3	630
3NE1437-0	Sitor Fuse Link	3	710
3NE1438-0	Sitor Fuse Link	3	800



Sitor - Semiconductor Fuses

Part Number Description Size Current (I)







gS - Semiconductor protection. 1000V AC

3NE4101	Sitor Fuse Link	0	32
3NE4118	Sitor Fuse Link	0	63
3NE4120	Sitor Fuse Link	0	80
3NE4121	Sitor Fuse Link	0	100
3NE4124	Sitor Fuse Link	0	100
3NE3222	Sitor Fuse Link	1	125
3NE3224	Sitor Fuse Link	1	160
3NE3225	Sitor Fuse Link	1	200
3NE3227	Sitor Fuse Link	1	250
3NE3230-0B	Sitor Fuse Link	1	315
3NE3231	Sitor Fuse Link	1	350
3NE3232-0B	Sitor Fuse Link	1	400
3NE3233	Sitor Fuse Link	1	450
3NE3333	Sitor Fuse Link	2	450
3NE3334-0B	Sitor Fuse Link	2	500
3NE3335	Sitor Fuse Link	2	560
3NE3336	Sitor Fuse Link	2	630
3NE3337-8	Sitor Fuse Link	2	710
3NE3338-8	Sitor Fuse Link	2	800
3NE3340-8	Sitor Fuse Link	2	900



LOW VOLTAGE POWER DISTRIBUTION

Fuses Accessories

Part Number	Description	Size	Current (I)	
Fuse accessories				
3NH3031	Fuse base, 1-pole	00	160	
3NH3230	Fuse base, 1-pole	1	250	
3NH3330	Fuse base, 1-pole	2	400	
3NH3430	Fuse base, 1-pole	3	630	
3NH3530	Fuse base, 1-pole	4	1250	
3NH4030	Fuse base, 3-pole	00	160	
3NH4230	Fuse base, 3-pole	1	250	
3NX1013	Fuse Puller without sleeve	000 - 4	-	
3NX1014	Fuse Puller with sleeve	000 - 4	-	
3NX2023	Phase & end barriers	000 / 00	-	
3NX2024	Phase & end barriers	1	-	
3NX2025	Phase & end barriers	2	-	
3NG1002	Solid copper links	00	160	
3NG1202	Solid copper links	1	250	
3NG1302	Solid copper links	2	400	
3NG1402	Solid copper links	3	630	

Technical Assistance :

<http://support.automation.siemens.com>

Share Call: 0860 80 80 80 (within RSA)

email: support.south-africa.automation@siemens.com

SIRIUS Innovations 3RT2 Size S0 Contractor, AC Coil Operation

Part Number	Pn @ 400VAC	Pn @ 500/525VAC	Coil V AC	Aux
Operational Current Ie @ 400V AC-3 Duty - 7A SIZE S00				
3RT2015-1AB01	3	3.5	24	1N/O
3RT2015-1AB02	3	3.5	24	1N/C
3RT2015-1AF01	3	3.5	110	1N/O
3RT2015-1AF02	3	3.5	110	1N/C
3RT2015-1AP01	3	3.5	220	1N/O
3RT2015-1AP02	3	3.5	220	1N/C

Operational Current Ie @ 400V AC-3 Duty - 9A SIZE S00

3RT2016-1AB01	4	4.5	24	1N/O
3RT2016-1AB02	4	4.5	24	1N/C
3RT2016-1AF01	4	4.5	110	1N/O
3RT2016-1AF02	4	4.5	110	1N/C
3RT2016-1AP01	4	4.5	220	1N/O
3RT2016-1AP02	4	4.5	220	1N/C

Operational Current Ie @ 400V AC-3 Duty - 12A SIZE S00

3RT2017-1AB01	5.5	5.5	24	1N/O
3RT2017-1AB02	5.5	5.5	24	1N/C
3RT2017-1AF01	5.5	5.5	110	1N/O
3RT2017-1AF02	5.5	5.5	110	1N/C
3RT2017-1AP01	5.5	5.5	220	1N/O
3RT2017-1AP02	5.5	5.5	220	1N/C

Operational Current Ie @ 400V AC-3 Duty - 16A SIZE S00

3RT2018-1AB01	7.5	7.5	24	1N/O
3RT2018-1AB02	7.5	7.5	24	1N/C
3RT2018-1AF01	7.5	7.5	110	1N/O
3RT2018-1AF02	7.5	7.5	110	1N/C
3RT2018-1AP01	7.5	7.5	220	1N/O
3RT2018-1AP02	7.5	7.5	220	1N/C



3RT2015-1A...

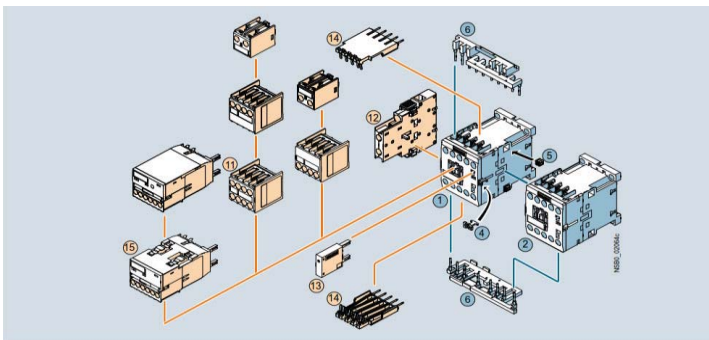

Mountable accessories (optional)

To be ordered separately	Type	Page
11 Auxiliary switch block, front ¹⁾	3RH2911	3/70 ... 3/72
12 Auxiliary switch block, lateral	3RH2921	3/73
13 Surge suppressors	3RT2916	3/77, 3/78
14 Solder pin adapters	3RT1916-4KA1	3/89
15 Function module for connection to the control system	3RA271 -1BA00	3/82

Complete reversing contactor assembly

Individual parts	Type	Q11	Q12	Page
1-2 Contactors, 3 kW	3RT2015	3RT2015	3/37, 3/42	
1-2 Contactors, 4 kW	3RT2016	3RT2016	3/37, 3/42	
1-2 Contactors, 5.5 kW	3RT2017	3RT2017	3/37, 3/42	
1-2 Contactors, 7.5 kW	3RT2018	3RT2018	3/37, 3/42	
4-5-6 Assembly kit comprising:	3RA2913-2AA1		3/85	

4 Mechanical interlock²⁾

5 Two connecting clips for two contactors²⁾

6 Wiring modules on the top and bottom for connecting the main current paths, electrical interlock included¹⁾, interruptible (NC contact interlock)

SIRIUS Innovations 3RT2 Size S0 Contractor, AC Coil Operation

Part Number Pn @ 400VAC Pn @ 500/525VAC Coil V AC Aux

Operational Current Ie @ 400V AC-3 Duty - 9A SIZE S0

3RT2023-1AB00	4	4	24	1N/O + 1N/C
3RT2023-1AF00	4	4	110	
3RT2023-1AP00	4	4	220	
3RT2023-1AV00	4	4	400	

Operational Current Ie @ 400V AC-3 Duty - 12A SIZE S0

3RT2024-1AB00	5.5	7.5	24	1N/O + 1N/C
3RT2024-1AF00	5.5	7.5	110	
3RT2024-1AP00	5.5	7.5	220	
3RT2024-1AV00	5.5	7.5	400	



Operational Current Ie @ 400V AC-3 Duty - 17A SIZE S0

3RT2025-1AB00	7.5	10	24	1N/O + 1N/C
3RT2025-1AF00	7.5	10	24	
3RT2025-1AP00	7.5	10	110	
3RT2025-1AV00	7.5	10	110	

Operational Current Ie @ 400V AC-3 Duty - 25A SIZE S0

3RT2026-1AB00	11	11	24	1N/O + 1NC
3RT2026-1AF00	11	11	110	
3RT2026-1AP00	11	11	220	
3RT2026-1AV00	11	11	400	

Operational Current Ie @ 400V AC-3 Duty - 32A SIZE S0

3RT2027-1AB00	15	18.5	24	1N/O + 1NC
3RT2027-1AF00	15	18.5	110	
3RT2027-1AP00	15	18.5	220	
3RT2027-1AV00	15	18.5	400	

Operational Current Ie @ 400V AC-3 Duty - 38A SIZE S0

3RT2028-1AB00	18.5	18.5	24	1N/O + 1NC
3RT2028-1AF00	18.5	18.5	110	
3RT2028-1AP00	18.5	18.5	220	
3RT2028-1AV00	18.5	18.5	400	

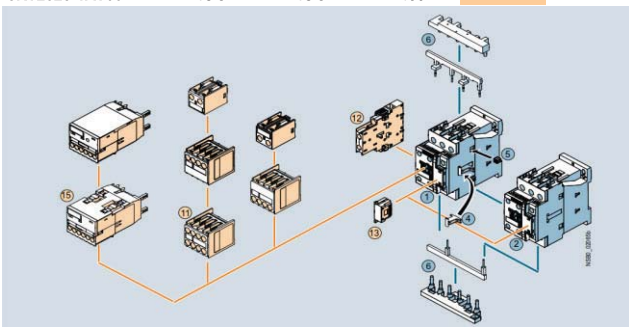

Mountable accessories (optional)

To be ordered separately	Type	Page
1 Auxiliary switch block, front	3RH2921	3/70 ... 3/72
2 Auxiliary switch block, lateral	3RH2921	3/73
3 Surge suppressors	3RT2926	3/77, 3/78
4 Function module for connection to the control system	3RAZ71.-1BA00	3/82

Complete reversing contactor assembly

Individual parts	Type	Page
1 2 Contactors, 5.5 kW	3RT2024	3/99, 3/46
1 2 Contactors, 7.5 kW	3RT2025	3/99, 3/46
1 2 Contactors, 11 kW	3RT2026	3/99, 3/46
1 2 Contactors, 15 kW	3RT2027	3/99, 3/46
1 2 Contactors, 18.5 kW	3RT2028	3/99, 3/46
4 2 1 Assembly kit comprising:	3RA2923-2AA1	3/85

- 1 Mechanical interlock¹⁾
- 2 Two connecting clips for two contactors¹⁾
- 3 Wiring modules on the top and bottom for connecting the main current paths, electrical interlock included (NC contact interlock)

SIRIUS Innovations 3RT2 Size S2 Contractor, AC Coil Operation

Part Number	Pn @ 400VAC	Pn @ 500/525VAC	Coil V AC	Aux
-------------	-------------	-----------------	-----------	-----

Operational Current I_e @ 400V AC-3 Duty - 40A SIZE S2

3RT2035-1AB00	18.5	22	24	1N/O + 1N/C
3RT2035-1AF00	18.5	22	110	
3RT2035-1AP00	18.5	22	220	
3RT2035-1AV00	18.5	22	400	

Operational Current I_e @ 400V AC-3 Duty - 50A SIZE S2

3RT2036-1AB00	22	30	24	1N/O + 1N/C
3RT2036-1AF00	22	30	110	
3RT2036-1AP00	22	30	220	
3RT2036-1AV00	22	30	400	

Operational Current I_e @ 400V AC-3 Duty - 65A SIZE S2

3RT2037-1AB00	30	37	24	1N/O + 1N/C
3RT2037-1AF00	30	37	24	
3RT2037-1AP00	30	37	110	
3RT2037-1AV00	30	37	110	

Operational Current I_e @ 400V AC-3 Duty - 80A SIZE S2

3RT2038-1AB00	37	37	24	1N/O + 1N/C
3RT2038-1AF00	37	37	110	
3RT2038-1AP00	37	37	220	
3RT2038-1AV00	37	37	400	

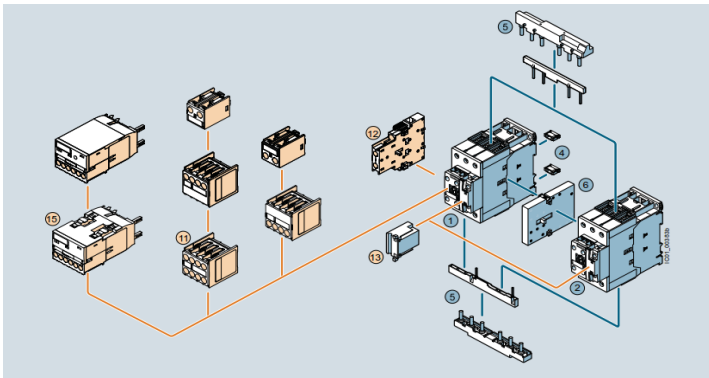

Mountable accessories (optional)

To be ordered separately	Type	Page
① Auxiliary switch block, front	3RH2921	3/70 ... 3/72
② Auxiliary switch block, lateral	3RH2921	3/73
③ Surge suppressors	3RT2936	3/77, 3/78
④ Function module for connection to the control system	3RA271.-1BA00	3/82

Complete reversing contactor assembly

Individual parts	Type	Q11	Q12	Page
① ②	Contactors, 16.5 kW	3RT2035	3RT2035	3/41, 3/51
① ②	Contactors, 22 kW	3RT2036	3RT2036	3/41, 3/51
① ②	Contactors, 30 kW	3RT2037	3RT2037	3/41, 3/51
① ②	Contactors, 37 kW	3RT2038	3RT2038	3/41, 3/51
④ ⑤	Assembly kit comprising:	3RA2933-2AA1		3/85
④	Two connectors for two contactors			
⑤	Wiring modules on the top and bottom for connecting the main and auxiliary current paths, electrical interlock (included (N/C contact interlock))			
⑥	Mechanical interlock	3RA2934-2B		3/87

Sirius Classic 3RT1 Size S3 - S6 Contractors

Part Number Pn @ 400VAC Pn @ 500/525VAC Coil V AC Aux

Operational Current Ie @ 400V AC-3 Duty - 65A SIZE S3

3RT1044-1AB00	30	37	24	No Aux-add 3RH1921-1***
3RT1044-1AF00	30	37	110	
3RT1044-1AP00	30	37	220	
3RT1044-1AV00	30	37	400	

Operational Current Ie @ 400V AC-3 Duty - 80A SIZE S2

3RT1045-1AB00	37	45	24	No Aux-add 3RH1921-1***
3RT1045-1AF00	37	45	110	
3RT1045-1AP00	37	45	220	
3RT1045-1AV00	37	45	400	



3RT104.-1A.00

Operational Current Ie @ 400V AC-3 Duty - 95A SIZE S2

3RT1046-1AB00	45	55	24	No Aux-add 3RH1921-1***
3RT1046-1AF00	45	55	110	
3RT1046-1AP00	45	55	220	
3RT1046-1AV00	45	55	400	

Operational Current Ie @ 400V AC-3 Duty-115A SIZE S6

3RT1054-1AF36	55	75	110 UC	2NO+2NC
3RT1054-1AP36	55	75	220 UC	
3RT1054-1AV36	55	75	400 UC	

Operational Current Ie @ 400V AC-3 Duty-150A SIZE S6

3RT1055-6AF36	75	90	110 UC	2NO+2NC
3RT1055-6AP36	75	90	220 UC	
3RT1055-6AV36	75	90	400 UC	



3RT105.

Operational Current Ie @ 400V AC-3 Duty-185A SIZE S6

3RT1056-6AF36	90	110	110 UC	2NO+2NC
3RT1056-6AP36	90	110	220 UC	
3RT1056-6AV36	90	110	400 UC	

Operational Current Ie @ 400V AC-3 Duty-225A SIZE S10

3RT1064-6AF36	110	160	110 UC	2NO+2NC
3RT1064-6AP36	110	160	220 UC	
3RT1064-6AV36	110	160	400 UC	

Operational Current Ie @ 400V AC-3 Duty-265A SIZE S10

3RT1065-6AF36	132	160	110 UC	2NO+2NC
3RT1065-6AP36	132	160	220 UC	
3RT1065-6AV36	132	160	400 UC	

Operational Current Ie @ 400V AC-3 Duty-300A SIZE S10

3RT1066-6AF36	160	200	110 UC	2NO+2NC
3RT1066-6AP36	160	200	220 UC	
3RT1066-6AV36	160	200	400 UC	



3RT106.

INDUSTRIAL CONTROLS

Sirius Classic 3RT1 Size S6 - S12 Contractors

Part Number Pn @ 400VAC Pn @ 500/525VAC Coil V AC Aux

Operational Current Ie @ 400V AC-3 Duty-400A SIZE S12

3RT1075-6AF36	200	250	110 UC	2NO+2NC
3RT1075-6AP36	200	250	220 UC	
3RT1075-6AV36	200	250	400 UC	



3RT1075

Operational Current Ie @ 400V AC-3 Duty-500A SIZE S12

3RT1075-6AF36	250	355	110 UC	2NO+2NC
3RT1075-6AP36	250	355	220 UC	
3RT1075-6AV36	250	355	400 UC	

Size S14 VACUUM CONTACTORS

Operational Current Ie @ 400V AC-3 Duty-630A SIZE S14

3TF6844-0CF7	335	434	110	4NO+4NC
3TF6944-0CP7	335	434	220	



3TF68/3TF69

Operational Current Ie @ 400V AC-3 Duty-820A SIZE S14

3TF6944-0CF7	480	600	110	4NO+4NC
3TF6944-0CP7	480	600	220	

Vacuum 3RT12 Contactors

Operational Current Ie @ 400V AC-3 Duty-225A SIZE S10

3RT1264-6AF36	110	160	110 UC	2NO+2NC
3RT1264-6AP36	110	160	220 UC	
3RT1264-6AV36	110	160	400 UC	

Operational Current Ie @ 400V AC-3 Duty-265A SIZE S10

3RT1265-6AF36	132	160	110 UC	2NO+2NC
3RT1265-6AP36	132	160	220 UC	
3RT1265-6AV36	132	160	400 UC	



3RT1265

Operational Current Ie @ 400V AC-3 Duty-300A SIZE S10

3RT1266-6AF36	160	200	110	2NO+2NC
3RT1266-6AP36	160	200	220	
3RT1266-6AV36	160	200	400	

Operational Current Ie @ 400V AC-3 Duty-400A SIZE S12

3RT1275-6AF36	200	250	110	2NO+2NC
3RT1275-6AP36	200	250	220	
3RT1275-6AV36	200	250	400	



3RT1275

Operational Current Ie @ 400V AC-3 Duty-500A SIZE S12

3RT1275-6AF36	250	355	110	2NO+2NC
3RT1275-6AP36	250	355	220	
3RT1275-6AV36	250	355	400	

INDUSTRIAL CONTROLS

Sirius Classic 3RT1 Size S6 - S12 Contractors - No Coil

Part Number	Pn @ 400VAC	Pn @ 500/525VAC	Coil V AC	Aux
Size S6 without coil (AC & DC CONTROL)				
3RT1054-6LA06	55	75	115A	2NO+2NC
3RT1055-6LA06	75	90	150A	
3RT1056-6LA06	90	110	185A	

Size S10 without coil (AC & DC CONTROL)				
3RT1064-6LA06	110	160	225A	2NO+2NC
3RT1065-6LA06	132	160	265A	
3RT1066-6LA06	160	200	300A	

Size S12 without coil (AC & DC CONTROL)				
3RT1075-6LA06	200	250	400A	2NO+2NC
3RT1076-6LA06	250	355	500A	

Size S10 Vacuum without coil (AC & DC CONTROL)				
3RT1264-6LA06	110	160	225A	2NO+2NC
3RT1265-6LA06	132	160	265A	
3RT1266-6LA06	160	200	300A	

Size S12 Vacuum without coil (AC & DC CONTROL)				
3RT1275-6LA06	200	250	400A	2NO+2NC
3RT1276-6LA06	250	355	500A	

Coils AC/DC Operation SIZE S6

3RT1955-5AF31	for 3RT105	110 - 127V
3RT1955-5AP31	for 3RT105	220 - 240V
3RT1955-5AV31	for 3RT105	380 - 420V
3RT1955-5AS31	for 3RT105	500 - 550V

Coils AC/DC Operation SIZE S10 - 3RT106

3RT1965-5AF31	for 3RT106	110 - 127V
3RT1965-5AP31	for 3RT106	220 - 240V
3RT1965-5AV31	for 3RT106	380 - 420V
3RT1965-5AS31	for 3RT106	500 - 550V

Coils AC/DC Operation SIZE S10 - 3RT126 Vacuum

3RT1966-5AF31	for 3RT106	110 - 127V
3RT1966-5AP31	for 3RT106	220 - 240V
3RT1966-5AV31	for 3RT106	380 - 420V
3RT1966-5AS31	for 3RT106	500 - 550V



Coils AC/DC Operation SIZE S12

3RT1975-5AF31	for 3RT107	110 - 127V
3RT1975-5AP31	for 3RT107	220 - 240V
3RT1975-5AV31	for 3RT107	380 - 420V
3RT1975-5AS31	for 3RT107	500 - 550V

Technical Assistance :

<http://support.automation.siemens.com>

Share Call: 0860 80 80 80 (within RSA)

email: support.south-africa.automation@siemens.com

Sirius Classic 3RT1 Size S3 - S12 Contractors - Reversing Kits

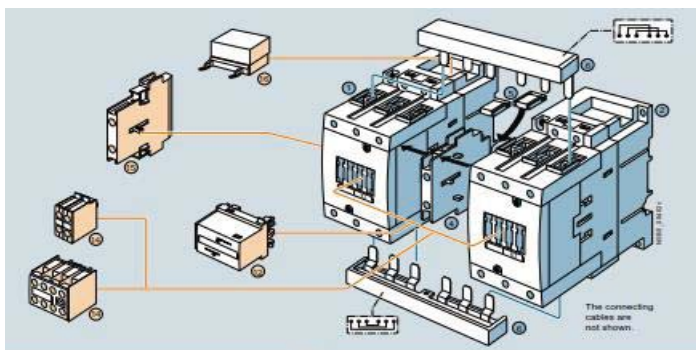

Mountable accessories (optional)

To be ordered separately	Type	Page
1	Mech. interlock, front 3RA1924-1A	3/130
2	Auxiliary switch block, front 3RT1921	3/122
3	Auxiliary switch block, lateral 3RT1921	3/123
4	Surge suppressors 3RT1936	3/126

Complete reversing contactor assembly

Individual parts	Type	Q1	Q2	Page
1	Contactors, 30 kW	3RT1044	3RT1044	3/111
2	Contactors, 37 kW	3RT1045	3RT1045	3/111
3	Contactors, 45 kW	3RT1046	3RT1046	3/111
4	Mechanical interlocks, lateral	3RA1924-2B		3/130
5	Assembly kit comprising:	3RA1943-2A		3/126

1 Two connectors for two contactors with 10 mm distance
 2 Wiring modules on the top and bottom for connecting the main current paths

Rated data AC-2 and AC-3 for 50 Hz 400 V AC		Size	Type	Mechanical interlock (see page 3/130)			Assembly kit (see page 3/126)
Rating	Operational current I_N		Contact (see from page 3/111 onwards)	Can be mounted onto the front	Laterally mountable With one auxiliary contact each	Without auxiliary contacts	
kW	A						
30	65	S3	3RT1044	3RA1924-1A	3RA1924-2B	--	3RA1943-2A ¹⁾
37	80		3RT1045				
45	95		3RT1046				
55	115	S6	3RT1054	--	--	3RA1954-2A	3RA1953-2M ²⁾
75	150		3RT1055				
90	185		3RT1056				
110	225	S10	3RT1064	--	--	3RA1954-2A	3RA1963-2A ²⁾
132	265		3RT1065				
160	300		3RT1066				
200	400	S12	3RT1075	--	--	3RA1954-2A	3RA1973-2A ²⁾
250	500		3RT1076				

¹⁾ The assembly kit contains: Two connectors for two contactors, as well as wiring modules on the top and bottom, see page 3/126.

²⁾ The assembly kit contains wiring modules on the top and bottom, see page 3/126.

Technical Assistance :

<http://support.automation.siemens.com>

Share Call: 0860 80 80 80 (within RSA)

email: support.south-africa.automation@siemens.com

Sirius Innovations 3RT2 Star - Delta Configuration

Start / Delta S00 individual component selection

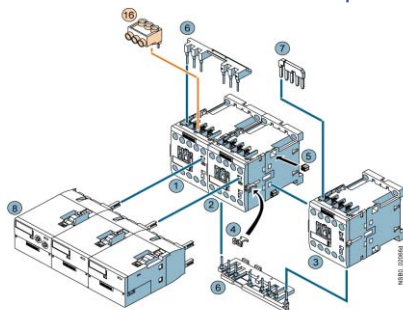

Mountable accessories (optional)

To be ordered separately	Type
16 Three-phase feeder terminal ¹⁾	3RA2913-3K

Complete contactor assembly for wye-delta starting

Individual parts	Type Q11	Q13	Q12
1 2 3 Contactor, 5.5 kW	3RT2015	3RT2015	3RT2015
1 2 3 Contactor, 7.5 kW	3RT2017	3RT2017	3RT2015
1 2 3 Contactor, 11 kW	3RT2018	3RT2018	3RT2015
4 ... 7 Assembly kit comprising:	3RA2913-2BB1		

- 4 Mechanical interlocks
- 5 Four connecting clips for three contactors
- 6 Wiring modules on the top and bottom for connecting the main and auxiliary circuits
- 7 Star jumper

¹⁾ Part 16 can only be mounted with contactors with screw terminal.

²⁾ The version with 1 NO is required for momentary-contact operation.

8 Function module wye-delta	3RA2816-0EW20
-----------------------------	---------------

Start / Delta S0 individual component selection

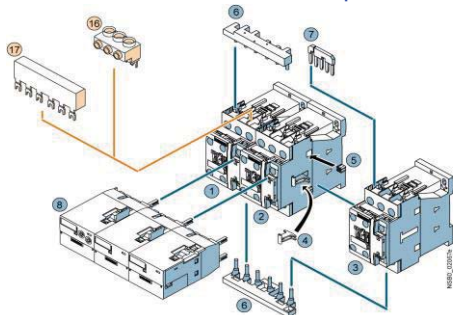

Mountable accessories (optional)

To be ordered separately	Type
16 Three-phase feeder terminal ¹⁾	3RV2925-5AB
17 Three-phase busbar ¹⁾	3RV1915-1AB

Complete contactor assembly for wye-delta starting

Individual parts	Type Q11	Q13	Q12
1 2 3 Contactor, 11 kW	3RT2024	3RT2024	3RT2024
1 2 3 Contactor, 15/18.5 kW	3RT2026	3RT2026	3RT2024
1 2 3 Contactor, 22 kW	3RT2027	3RT2027	3RT2026
4 ... 7 Assembly kit	3RA2923-2BB1		

- The assembly kit contains:
- 4 Mechanical interlocks
 - 5 Connecting clips
 - 6 Wiring modules on the top and bottom for connecting the main current paths
 - 7 Star jumper

¹⁾ The parts 16 and 17 can only be mounted with contactors with screw terminal.

8 Function module wye-delta	3RA2816-0EW20
-----------------------------	---------------

Sirius Innovations 3RT2 Star - Delta Configuration

Start / Delta S2 individual component selection

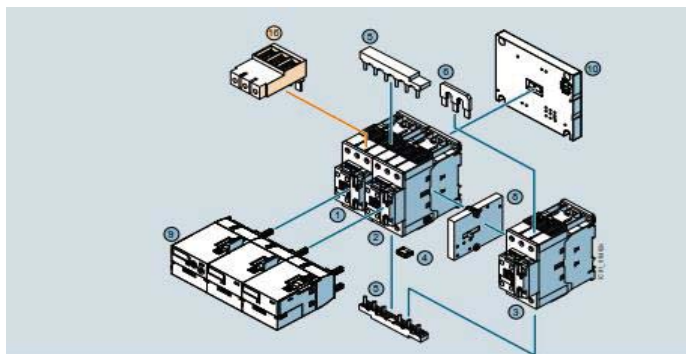

Mountable accessories (optional)

To be ordered separately

Type	Page
⑩ Three-phase interlock terminal ²⁾ 3RV2935-5A	3/88

Complete contactor assembly for star-delta (wye-delta) starting

Individual parts

Type	Q11	Q13	Q12
① ② ③ Contactors, 22/30 kW	3RT2030	3RT2035	3RT2026
① ② ③ Contactors, 37 kW	3RT2030	3RT2035	3RT2027
① ② ③ Contactors, 45 kW	3RT2030	3RT2036	3RT2028
① ② ③ Contactors, 55 kW	3RT2037	3RT2037	3RT2035
④ ... ⑦ Assembly kit S2-S2-S2 comprising:	3RA2933-2BB1		
④ Four connectors for three contactors (not required for fully pre-wired contactor assemblies for star-delta (wye-delta) starting)			
⑤ Wiring modules on top and bottom for connecting the main and auxiliary circuits			
⑥ Star jumper S2			
⑦ Cable for connecting the A2 coil contact from the line contactor with the A2 coil contact of the delta contactor (not shown in the drawing)			
⑧ Mechanical interlock	3RA2934-2B		
⑨ Function modules for star-delta (wye-delta) starting	3RA2816-0EW20		
⑩ Base plate star-delta (wye-delta)	3RA2932-2F		

Rated data at 50 Hz 400 V AC			Size	Type	
Rating P	Operational current I_N	Motor current		Line/delta contactor	
kW	A	A		Star contactor	
55	115	77.6 ... 108.0	93-93-S2	3RT1044	3RT1035
75	150	120.7 ... 150		3RT1045	3RT1036
90	160	86 ... 160	96-96-S3	3RT1054	3RT1044
110	195	86 ... 195			
132	230	86 ... 230		3RT1055	3RT1045
160	280	86 ... 280		3RT1056	3RT1046
200	350	95 ... 350	S10-S10-S5	3RT1064	3RT1054
250	430	95 ... 430		3RT1065	3RT1055
315	540	277 ... 540	S12-S12-S10	3RT1075	3RT1064
355	610	277 ... 610			
400	690	277 ... 690			3RT1065
500	850	277 ... 850		3RT1076	3RT1066

Rating P	Accessories for customer assembly				Overload relay, thermal (CLASS 10 trip class)		Overload relay, electronic (CLASS 10 trip class)		
	Timing relays (see page 1/105)	Assembly kit (see page 3/126) For double interlock	For single interlock	Star jumper (see page 3/129)	Base plate (see page 3/131)	Setting range A	Type	Setting range A	Type
55	3RP2574-1N_30	3RA1943-2C ¹⁾	--	3RT1935-4BA31	3RA1942-2E	45 ... 63	3RU1146-4JB0	25 ... 100	3RB2046-1EB0
75						70 ... 90	3RU1146-4LB0		
90	3RP2574-1N_30	--	3RA1953-3D ²⁾	3RT1946-4BA31	3RA1952-2E	--	--	50 ... 200	3RB2066-1FC2
110									
132									
160									
200	3RP2574-1N_30	--	--	3RT1956-4BA31	3RA1962-2E	--	--	55 ... 250	3RB2066-1GC2
250								160 ... 630	3RB2066-1MC2
315	3RP2574-1N_30	--	--	3RT1966-4BA31	3RA1972-2E	--	--	160 ... 630	3RB2066-1MC2
355									
400									
500									

Sirius Innovations 3RT2 Contractor DC Coil Operation

Part Number Pn @ 400VAC Pn @ 500/525VAC Coil V DC Aux

Operational Current Ie @ 400V AC-3 Duty - 7A SIZE S00

3RT2015-1BB41	3	3.5	24	1N/O
3RT2015-1BB42	3	3.5	24	1N/C
3RT2015-1BB41	3	3.5	110	1N/O
3RT2015-1BB42	3	3.5	110	1N/C
3RT2015-1BB41	3	3.5	220	1N/O
3RT2015-1BB42	3	3.5	220	1N/C

Operational Current Ie @ 400V AC-3 Duty - 9A SIZE S00

3RT2016-1BB41	4	4.5	24	1N/O
3RT2016-1BB42	4	4.5	24	1N/C
3RT2016-1BF41	4	4.5	110	1N/O
3RT2016-1BF42	4	4.5	110	1N/C
3RT2016-1BP41	4	4.5	220	1N/O
3RT2016-1BP42	4	4.5	220	1N/C



3RT2015-1A...

Operational Current Ie @ 400V AC-3 Duty - 12A SIZE S00

3RT2017-1BB41	5.5	5.5	24	1N/O
3RT2017-1BB42	5.5	5.5	24	1N/C
3RT2017-1BF41	5.5	5.5	110	1N/O
3RT2017-1BF42	5.5	5.5	110	1N/C
3RT2017-1BP41	5.5	5.5	220	1N/O
3RT2017-1BP42	5.5	5.5	220	1N/C

Operational Current Ie @ 400V AC-3 Duty - 16A SIZE S00

3RT2018-1BB41	7.5	7.5	24	1N/O
3RT2018-1BB42	7.5	7.5	24	1N/C
3RT2018-1BF41	7.5	7.5	110	1N/O
3RT2018-1BF42	7.5	7.5	110	1N/C
3RT2018-1BP41	7.5	7.5	220	1N/O
3RT2018-1BP42	7.5	7.5	220	1N/C

Operational Current Ie @ 400V AC-3 Duty - 9A SIZE S0

3RT2023-1BB40	4	4	24	1N/O + 1N/C
3RT2023-1BF40	4	4	110	
3RT2023-1BM40	4	4	220	

Operational Current Ie @ 400V AC-3 Duty - 12A SIZE S0

3RT2024-1BB40	5.5	7.5	24	1N/O + 1N/C
3RT2024-1BF40	5.5	7.5	110	
3RT2024-1BM40	5.5	7.5	220	



3RT2023-1B...40

Operational Current Ie @ 400V AC-3 Duty - 17A SIZE S0

3RT2025-1BB40	7.5	10	24	1N/O + 1N/C
3RT2025-1BF40	7.5	10	24	
3RT2025-1BM40	7.5	10	110	

INDUSTRIAL CONTROLS

Sirius Innovations 3RT2 Size S0 & S2 Contractor - DC Coil Operation, Size S3 3RT1

Part Number Pn @ 400VAC Pn @ 500/525VAC Coil V DC Aux

Operational Current Ie @ 400V AC-3 Duty - 25A SIZE S0

3RT2026-1BB40	11	11	24	1N/O + 1NC
3RT2026-1BF40	11	11	110	
3RT2026-1BM40	11	11	220	

Operational Current Ie @ 400V AC-3 Duty - 32A SIZE S0

3RT2027-1BB40	15	18.5	24	1N/O + 1NC
3RT2027-1BF40	15	18.5	110	
3RT2027-1BM40	15	18.5	220	



3RT2026.-1B.40

Operational Current Ie @ 400V AC-3 Duty - 38A SIZE S0

3RT2028-1BB40	18.5	18.5	24	1N/O + 1NC
3RT2028-1BF40	18.5	18.5	110	
3RT2028-1BM40	18.5	18.5	220	

Operational Current Ie @ 400V AC-3 Duty - 40A SIZE S2

3RT2035-1KB40	18.5	22	24	1NO+1NC
---------------	------	----	----	---------

Operational Current Ie @ 400V AC-3 Duty - 50A SIZE S2

3RT2036-1KB40	22	30	24	1NO+1NC
---------------	----	----	----	---------

Operational Current Ie @ 400V AC-3 Duty - 65A SIZE S2

3RT2037-1KB40	30	37	24	1NO+1NC
---------------	----	----	----	---------

Operational Current Ie @ 400V AC-3 Duty - 80A SIZE S2

3RT2038-1KB40	37	37	24	1NO+1NC
---------------	----	----	----	---------



3RT2035.-1KB40

Operational Current Ie @ 400V AC-3 Duty-65A SIZE S3

3RT1044-1BB40	30	37	24	No Aux-add 3RH1921-1****
3RT1044-1BF40	30	37	110	
3RT1044-1BM40	30	37	220	

Operational Current Ie @ 400V AC-3 Duty-80A SIZE S3

3RT1045-1BB40	37	45	24	No Aux-add 3RH1921-1****
3RT1045-1BF40	37	45	110	
3RT1045-1BM40	37	45	220	



3RT1044.-1B.40

Operational Current Ie @ 400V AC-3 Duty-95A SIZE S3

3RT1046-1BB40	45	55	24	No Aux-add 3RH1921-1****
3RT1046-1BF40	45	55	110	
3RT1046-1BM40	45	55	220	

Sirius Innovations 3RT2 Contractor For Special Applications

Part Number Pn @ 400VAC Pn @ 500/525VAC Coil Voltage Aux

PLC Optimized 3RT2 contactors AC-3 with AC/DC electronic coils. 0.7 ...
1.3 x Us with Integrated Varistor

3RT2024-1NB30	5.5	7.5	21 - 28	1N/O * 1NC
3RT2024-1NF30	5.5	7.5	95 - 130	
3RT2024-1NP30	5.5	7.5	200 - 280	
3RT2025-1NB30	7.5	10	21 - 28	1N/O * 1NC
3RT2025-1NF30	7.5	10	95 - 130	
3RT2025-1NP30	7.5	10	200 - 280	
3RT2026-1NB30	11	11	21 - 28	1N/O * 1NC
3RT2026-1NF30	11	11	95 - 130	
3RT2026-1NP30	11	11	200 - 280	
3RT2027-1NB30	15	18.5	21 - 28	1N/O * 1NC
3RT2027-1NF30	15	18.5	95 - 130	
3RT2027-1NP30	15	18.5	200 - 280	
3RT2028-1NB30	18.5	18.5	21 - 28	1N/O * 1NC
3RT2028-1NF30	18.5	18.5	95 - 130	
3RT2028-1NP30	18.5	18.5	200 - 280	



3RT202-1N.30

3RT23 Contactors for Switching Resistive Loads (AC-1) 4-pole 4N/O

Part Number	Pn @ 400VAC	Ie (A) 40°C/60°C	Control voltage VAC		
3RT2316-1AB00	12	18/16	24	S0	0
3RT2316-1AF00	12	18/16	110		
3RT2316-1AP00	12	18/16	230		
3RT2317-1AB00	14.5	22/20	24	S0	0
3RT2317-1AF00	14.5	22/20	110		
3RT2317-1AP00	14.5	22/20	230		
3RT2325-1AB00	22	35/30	24	S0	
3RT2325-1AF00	22	35/30	110		
3RT2325-1AP00	22	35/30	230		
3RT2326-1AB00	26	40/35	24	S0	
3RT2326-1AF00	26	40/35	110		
3RT2326-1AP00	26	40/35	230		
3RT2327-1AB00	33	50	24	S0	
3RT2327-1AF00	33	50	110		
3RT2327-1AP00	33	50	230		



3RT231-1A.00

3RT25 Contactors 4-pole 2N/O + 2N/C

Part Number	Pn @ 400VAC	Ie (A) upto 60°C	Control voltage VAC		
3RT2516-1AB00	4	9	24	S0	0
3RT2516-1AF00	4	9	110		
3RT2516-1AP00	4	9	230		
3RT2517-1AB00	5.5	12	24	S0	0
3RT2517-1AF00	5.5	12	110		
3RT2517-1AP00	5.5	12	230		
3RT2525-1AB00	7.5	16	24	S0	
3RT2525-1AF00	7.5	16	110		
3RT2525-1AP00	7.5	16	230		
3RT2526-1AB00	11	25	24	S0	
3RT2526-1AF00	11	25	110		
3RT2526-1AP00	11	25	230		



3RT251-1A.00



3RT252-1A.00

Sirius Innovations 3RT2 Contractor - Accessories

Part Number Description Details

Snap-on auxiliary switch blocks S00 ... S2 - EN 50012

3RH2911-1HA11	Screw terminals, S00/S0	1N/O + 1N/C
3RH2911-1HA22	Screw terminals, S00/S0	2N/O + 2N/C
3RH2911-1HA13	Screw terminals, S00/S0	1N/O + 3N/C
3RH2911-1HA31	Screw terminals, S00/S0	3N/O + 1N/C



Snap-on auxiliary switch blocks S00 ... S2 - EN 50005

3RH2911-1FA40	Screw terminals, S00/S0	4N/O
3RH2911-1AA10	Screw terminals, S00/S0	1N/O
3RH2911-1AA01	Screw terminals, S00/S0	1N/C



Lateral auxiliary switch blocks S00

3RH2911-1DA02	Screw terminals, Right or Left	2N/O
3RH2911-1DA11	Screw terminals, Right or Left	1N/O + 1N/C
3RH2911-1DA20	Screw terminals, Right or Left	2N/C



Lateral auxiliary switch blocks S0 & S2

3RH2921-1DA02	Screw terminals, Right or Left	2N/O
3RH2921-1DA11	Screw terminals, Right or Left	1N/O + 1N/C
3RH2921-1DA20	Screw terminals, Right or Left	2N/C

Snap-on Solid-state auxiliary switch blocks S00 ... S2 - Dusty Environments

3RH2911-1NF11	Screw terminals, S00 ... S2	1NO + 1NC
3RH2911-1NF20	Screw terminals, S00 ... S2	2NO
3RH2911-1NF02	Screw terminals, S00 ... S2	2NC



Lateral Solid-state auxiliary switch blocks for Dusty Environments

3RH2911-2DE11	S00 Spring-type terminals, Right or Left	1N/O + 1N/C
3RH2921-2DE11	S0 & S2 Spring-type terminals, Right or Left	1N/O + 1N/C



Surge suppressors without LED for Size S00 3RT2.1 & 3RH2

3RT2916-1BB00	Varistor, AC 24-48V, DC 24 - 70V
3RT2916-1BC00	Varistor, AC 48-127V, DC 70 - 150V
3RT2916-1BD00	Varistor, AC 127-240V, DC 150 - 250V
3RT2916-1BE00	Varistor, AC 240 - 400V
3RT2916-1BF00	Varistor, AC 400 - 600V
3RT2916-1CB00	RC Element, AC 24-48V, DC 24 - 70V
3RT2916-1CC00	RC Element, AC 48-127V, DC 70 - 150V
3RT2916-1CD00	RC Element, AC 127-240V, DC 150 - 250V
3RT2916-1CE00	RC Element, AC 240 - 400V
3RT2916-1CF00	RC Element, AC 400 - 600V

With LED available

3RT2916-1DG00 Noise suppression diode, DC 12 - 250V

3RT2916-1EH00 Diode assembly (diode & Zener diode), DC 12 - 250V



Sirius Innovations 3RT2 Contractor - Accessories

Part Number Description Details

Surge suppressors without LED for Size S0 3RT2.1

With LED available

3RT2926-1BB00	Varistor, AC 24-48V, DC 24 - 70V
3RT2926-1BC00	Varistor, AC 48-127V, DC 70 - 150V
3RT2926-1BD00	Varistor, AC 127-240V, DC 150 - 250V
3RT2926-1BE00	Varistor, AC 240 - 400V
3RT2926-1BF00	Varistor, AC 400 - 600V



3RT2926-1E.00

3RT2926-1CB00	RC Element, AC 24-48V, DC 24 - 70V
3RT2926-1CC00	RC Element, AC 48-127V, DC 70 - 150V
3RT2926-1CD00	RC Element, AC 127-240V, DC 150 - 250V
3RT2926-1CE00	RC Element, AC 240 - 400V
3RT2926-1CF00	RC Element, AC 400 - 600V

3RT2926-1ER00	Diode assembly DC 24V
3RT2926-1ES00	Diode assembly DC 30 - 250V

Surge suppressors without LED for Size S2 3RT2.1

With LED available

3RT2936-1BB00	Varistor, AC 24-48V, DC 24 - 70V
3RT2936-1BC00	Varistor, AC 48-127V, DC 70 - 150V
3RT2936-1BD00	Varistor, AC 127-240V, DC 150 - 250V
3RT2936-1BE00	Varistor, AC 240 - 400V
3RT2936-1BF00	Varistor, AC 400 - 600V



3RT2936-1B.00

3RT2936-1CB00	RC Element, AC 24-48V, DC 24 - 70V
3RT2936-1CC00	RC Element, AC 48-127V, DC 70 - 150V
3RT2936-1CD00	RC Element, AC 127-240V, DC 150 - 250V
3RT2936-1CE00	RC Element, AC 240 - 400V
3RT2936-1CF00	RC Element, AC 400 - 600V

3RT2936-1ER00	Diode assembly DC 24V
3RT2936-1ES00	Diode assembly DC 30 - 250V

Magnetic coils - AC operation - Size S0 - 3RT2023 / 3RT2024 / 3RT2025...

3RT2924-5AB01	24V AC 50Hz
3RT2924-5AF01	110V AC 50Hz
3RT2924-5AP01	230V AC 50Hz
3RT2924-5AV01	400V AC 50Hz



3RT2924-5A.01

Magnetic coils - AC operation - Size S0 - 3RT2026 / 3RT2027 / 3RT2028...

3RT2924-5AB01	24V AC 50Hz
3RT2924-5AF01	110V AC 50Hz
3RT2924-5AP01	230V AC 50Hz
3RT2924-5AV01	400V AC 50Hz

Magnetic coils - AC operation - Size S2 - 3RT203 / 3RT233 / 3RT235...

3RT2934-5AB01	24V AC 50Hz
3RT2934-5AF01	110V AC 50Hz
3RT2934-5AP01	230V AC 50Hz
3RT2934-5AV01	400V AC 50Hz



3RT2934 5A.01

Main contact tips - S2 - 3RT203...

3RT2935-6A	1 set = 3 movable and 6 fixed switching elements
3RT2936-6A	
3RT2937-6A	
3RT2938-6A	

Sirius Innovations 3RT1 Contractor - Accessories

Part Number	Description	Details
Snap-on auxiliary switch blocks S3 - S12		
3RH1921-1FA40	4-pole	4N/O
3RH1921-1FA31	4-pole	3N/O + 1N/C
3RH1921-1FA22	4-pole	2N/O + 2N/C
3RH1921-1FA04	4-pole	4N/C
3RH1921-1LA11	2- pole	1N/O + 1N/C
3RH1921-1CA01	1-pole	1N/C
3RH1921-1CA10	1-pole	1N/O



3RH1921-1FA...
3RH1921-1FA...

Lateral auxiliary switch blocks S3-S12		
3RH1921-1DA11	First laterally mounted,2-P	1N/O + 1N/C
3RH1921-1EA20	First laterally mounted,2-P	2N/O
3RH1921-1EA11	First laterally mounted,2-P	1N/O + 1N/C
3RH1921-1EA02	First laterally mounted,2-P	2N/C



3RH1921-1DA11,
3RH1921-1JA11,
3RH1921-1EA...
3RH1921-1KA...

Lateral auxiliary switch blocks S3-S12		
3RH1921-1JA11	First laterally mounted,2-P	1N/O + 1N/C
3RH1921-1KA20	First laterally mounted,2-P	2N/O
3RH1921-1KA11	First laterally mounted,2-P	1N/O + 1N/C
3RH1921-1KA02	First laterally mounted,2-P	2N/C

Contacts with fixing parts		
3RT1944-6A	Main contacts sets, 3 movable and 6 fixed contacts	3RT1044
3RT1945-6A		3RT1045
3RT1946-6A		3RT1046
3RT1954-6A		3RT1054.
3RT1955-6A		3RT1055.
3RT1956-6A		3RT1056.
3RT1964-6A		3RT1064
3RT1965-6A		3RT1065.
3RT1966-6A		3RT1066.
3RT1975-6A		3RT1075.
3RT1976-6A		3RT1076.

Coils AC Operation SIZE S2		
3RT1934-5AF01	for 3RT1034	110V
3RT1934-5AP01	for 3RT1034	220V
3RT1934-5AV01	for 3RT1034	400V
3RT1935-5AF01	for 3RT1035/36	110V
3RT1935-5AP01	for 3RT1035/36	220V
3RT1935-5AV01	for 3RT1035/36	400V

Coils AC Operation SIZE S3		
3RT1944-5AF01	for 3RT1044	110V
3RT1944-5AP01	for 3RT1044	220V
3RT1944-5AV01	for 3RT1044	400V
3RT1945-5AF01	for 3RT1045/46	110V
3RT1945-5AP01	for 3RT1045/46	220V
3RT1945-5AV01	for 3RT1045/46	400V

Sirius Innovations 3RT2 Contractor Relays

Part Number	Ie AC-15/AC-14 @ 230V	Contacts Identification	Coil V AC	Aux. Contacts
3RH2140-1AB00	10	40 E	24	4N/O
3RH2140-1AF00	10	40 E	110	
3RH2140-1AP00	10	40 E	220	
3RH2131-1AB00	10	31 E	24	3N/O + 1NC
3RH2131-1AF00	10	31 E	110	
3RH2131-1AP00	10	31 E	220	
3RH2122-1AB00	10	22 E	24	2N/O + 2NC
3RH2122-1AF00	10	22 E	110	
3RH2122-1AP00	10	22 E	220	



Part Number	Ie AC-15/AC-14 @ 230V	Contacts Identification	Coil V DC	Aux. Contacts
3RH2140-1BB40	10	40 E	24	4N/O
3RH2140-1BF40	10	40 E	110	
3RH2140-1BP40	10	40 E	220	
3RH2131-1BB40	10	31 E	24	3N/O + 1NC
3RH2131-1BF40	10	31 E	110	
3RH2131-1BP40	10	31 E	220	
3RH2122-1BB40	10	22 E	24	2N/O + 2NC
3RH2122-1BF40	10	22 E	110	
3RH2122-1BP40	10	22 E	220	



3RH24 Latches contactor relays, 4-pole

Part Number	Ie AC-15/AC-14 @ 230V	Contacts Identification	Coil V AC	Aux. Contacts
3RH2440-1AB00	10	40 E	24	4N/O
3RH2440-1AF00	10	40 E	110	
3RH2440-1AP00	10	40 E	220	
3RH2431-1AB00	10	31 E	24	3N/O + 1NC
3RH2431-1AF00	10	31 E	110	
3RH2431-1AP00	10	31 E	220	
3RH2422-1AB00	10	22 E	24	2N/O + 2NC
3RH2422-1AF00	10	22 E	110	
3RH2422-1AP00	10	22 E	220	



Part Number	Ie AC-15/AC-14 @ 230V	Contacts Identification	Coil V DC	Aux. Contacts
3RH2440-1BB40	10	40 E	24	4N/O
3RH2440-1BF40	10	40 E	110	
3RH2440-1BM40	10	40 E	220	
3RH2431-1BB40	10	31 E	24	3N/O + 1NC
3RH2431-1BF40	10	31 E	110	
3RH2431-1BM40	10	31 E	220	
3RH2422-1BB40	10	22 E	24	2N/O + 2NC
3RH2422-1BF40	10	22 E	110	
3RH2422-1BM40	10	22 E	220	



Technical Assistance :

<http://support.automation.siemens.com>

Share Call: 0860 80 80 80 (within RSA)

email: support.south-africa.automation@siemens.com

Sirius Innovations 3RT2 Contractor Relays - PLC Optimised

Part Number	Description	le AC-15/AC-14 @ 230V	Aux. Contacts
-------------	-------------	-----------------------	---------------

PLC Optimized 3RH2 contactor relay, 0.7 ... 1.25 x Us. Low power consumption coils 2.8W @ 24V DC - screw terminals

3RH2140-1HB40	10	40 E	10 4N/O
3RH2131-1HB40	10	31 E	10 3N/O + 1N/C
3RH2122-1HB40	10	22 E	10 2N/O + 2N/C

3RH2140-1JB40	Built-in Diode	10	4N/O
3RH2131-1JB40	Built-in Diode	10	3N/O + 1N/C
3RH2122-1JB40	Built-in Diode	10	2N/O + 2N/C

3RH2140-1KB40	Built-in suppression diode	10	4N/O
3RH2131-1KB40	Built-in suppression diode	10	3N/O + 1N/C
3RH2122-1KB40	Built-in suppression diode	10	2N/O + 2N/C



PLC Optimized 3RH2 contactor relay, 0.85 ... 1.85 x Us. Low power consumption coils 1.6W @ 24V DC - screw terminals

3RH2140-1VB40	Built-in Diode	10	4N/O
3RH2131-1VB40	Built-in Diode	10	3N/O + 1N/C
3RH2122-1VB40	Built-in Diode	10	2N/O + 2N/C

3RH2140-1SB40	Built-in suppression diode	10	4N/O
3RH2131-1SB40	Built-in suppression diode	10	3N/O + 1N/C
3RH2122-1SB40	Built-in suppression diode	10	2N/O + 2N/C



Snap-on auxiliaries for 3RH2 contactor relays

Part Number	Description	Details
3RH2911-1GA40	Screw terminals, S00	4N/O
3RH2911-1GA31	Screw terminals, S00	3N/O + 1N/C
3RH2911-1GA22	Screw terminals, S00	2N/O + 2N/C
3RH2911-1GA13	Screw terminals, S00	1N/O + 3N/C
3RH2911-1GA04	Screw terminals, S00	4N/C



Surge suppressors without LED for Size S00 3RT2.1 & 3RH2

3RT2916-1BB00	Varistor, AC 24-48V, DC 24 - 70V
3RT2916-1BC00	Varistor, AC 48-127V, DC 70 - 150V
3RT2916-1BD00	Varistor, AC 127-240V, DC 150 - 250V
3RT2916-1BE00	Varistor, AC 240 - 400V
3RT2916-1BF00	Varistor, AC 400 - 600V
3RT2916-1CB00	RC Element, AC 24-48V, DC 24 - 70V
3RT2916-1CC00	RC Element, AC 48-127V, DC 70 - 150V
3RT2916-1CD00	RC Element, AC 127-240V, DC 150 - 250V
3RT2916-1CE00	RC Element, AC 240 - 400V
3RT2916-1CF00	RC Element, AC 400 - 600V
3RT2916-1DG00	Noise suppression diode, DC 12 - 250V
3RT2916-1EH00	Diode assembly (diode & Zener diode), DC 12 - 250V

With LED available



Technical Assistance :

<http://support.automation.siemens.com>

Share Call: 0860 80 80 80 (within RSA)

email: support.south-africa.automation@siemens.com

INDUSTRIAL CONTROLS

Sirius Classic 3RT1 Contractor - AC Coil

Part Number	Pn @ 400VAC	Pn @ 500/ 525VAC	Coil V AC	Aux
-------------	----------------	---------------------	-----------	-----

Operational Current Ie @ 400V AC-3 Duty-7A SIZE S00

3RT1015-1AB01	3	3.5	24	1N/O
3RT1015-1AB02	3	3.5	24	1N/C
3RT1015-1AF01	3	3.5	110	1N/O
3RT1015-1AF02	3	3.5	110	1N/C
3RT1015-1AP01	3	3.5	220	1N/O
3RT1015-1AP02	3	3.5	220	1N/C
3RT1015-1AV01	3	3.5	400	1N/O
3RT1015-1AS01	3	3.5	500	1N/O

Operational Current Ie @ 400V AC-3 Duty-9A SIZE S00

3RT1016-1AB01	4	4.5	24	1N/O
3RT1016-1AB02	4	4.5	24	1N/C
3RT1016-1AF01	4	4.5	110	1N/O
3RT1016-1AF02	4	4.5	110	1N/C
3RT1016-1AP01	4	4.5	220	1N/O
3RT1016-1AP02	4	4.5	220	1N/C
3RT1016-1AV01	4	4.5	400	1N/O
3RT1016-1AS01	4	4.5	500	1N/O

Operational Current Ie @ 400V AC-3 Duty-12A SIZE S00

3RT1017-1AB01	5.5	5.5	24	1N/O
3RT1017-1AB02	5.5	5.5	24	1N/C
3RT1017-1AF01	5.5	5.5	110	1N/O
3RT1017-1AF02	5.5	5.5	110	1N/C
3RT1017-1AP01	5.5	5.5	220	1N/O
3RT1017-1AP02	5.5	5.5	220	1N/C
3RT1017-1AV01	5.5	5.5	400	1N/O
3RT1017-1AS01	5.5	5.5	500	1N/O

Operational Current Ie @ 400V AC-3 Duty-9A SIZE S0

3RT1023-1AB00	4	5.5	24	-
3RT1023-1AF00	4	5.5	110	-
3RT1023-1AP00	4	5.5	220	-
3RT1023-1AV00	4	5.5	400	-
3RT1023-1AQ20	4	5.5	500	-

Operational Current Ie @ 400V AC-3 Duty-12A SIZE S0

3RT1024-1AB00	5.5	7.5	24	-
3RT1024-1AF00	5.5	7.5	110	-
3RT1024-1AP00	5.5	7.5	220	-
3RT1024-1AV00	5.5	7.5	400	-
3RT1024-1AQ20	5.5	7.5	500	-

INDUSTRIAL CONTROLS

Sirius Classic 3RT1 Contractor

Part Number	Pn @ 400VAC	Pn @ 500/ 525VAC	Coil V AC	Aux
Operational Current Ie @ 400V AC-3 Duty-17A SIZE S0				
3RT1025-1AB00	7.5	10	24	-
3RT1025-1AF00	7.5	10	110	-
3RT1025-1AP00	7.5	10	220	-

Operational Current Ie @ 400V AC-3 Duty-25A SIZE S0				
3RT1026-1AB00	11	11	24	-
3RT1026-1AF00	11	11	110	-
3RT1026-1AP00	11	11	220	-

Operational Current Ie @ 400V AC-3 Duty-32A SIZE S2				
3RT1034-1AB00	15	18,5	24	-
3RT1034-1AF00	15	18,5	110	-
3RT1034-1AP00	15	18,5	220	-

Operational Current Ie @ 400V AC-3 Duty-40A SIZE S2				
3RT1035-1AB00	18,5	22	24	-
3RT1035-1AF00	18,5	22	110	-
3RT1035-1AP00	18,5	22	220	-

Operational Current Ie @ 400V AC-3 Duty-50A SIZE S2				
3RT1036-1AB00	22	30	24	-
3RT1036-1AF00	22	30	110	-
3RT1036-1AP00	22	30	220	-

Part Number	Pn @ 400VAC	Pn @ 500/ 525VAC	Coil V DC	Aux
Operational Current Ie @ 400V AC-3 Duty-7A SIZE S00				
3RT1015-1BB41	3	3,5	24	1N/O
3RT1015-1BB42	3	3,5	24	1N/C
3RT1015-1BF41	3	3,5	110	1N/O
3RT1015-1BF42	3	3,5	110	1N/C
3RT1015-1BM41	3	3,5	220	1N/O
3RT1015-1BM42	3	3,5	220	1N/C

Operational Current Ie @ 400V AC-3 Duty-9A SIZE S00				
3RT1016-1BB41	4	4,5	24	1N/O
3RT1016-1BB42	4	4,5	24	1N/C
3RT1016-1BF41	4	4,5	110	1N/O
3RT1016-1BF42	4	4,5	110	1N/C
3RT1016-1BM41	4	4,5	220	1N/O
3RT1016-1BM42	4	4,5	220	1N/C

Operational Current Ie @ 400V AC-3 Duty-12A SIZE S00				
3RT1017-1BB41	5,5	5,5	24	1N/O
3RT1017-1BB42	5,5	5,5	24	1N/C
3RT1017-1BF41	5,5	5,5	110	1N/O
3RT1017-1BF42	5,5	5,5	110	1N/C
3RT1017-1BM41	5,5	5,5	220	1N/O
3RT1017-1BM42	5,5	5,5	220	1N/C

Technical Assistance :

<http://support.automation.siemens.com>

Share Call: 0860 80 80 80 (within RSA)

email: support.south-africa.automation@siemens.com

Sirius Classic 3RT1 Contractor

Part Number	Pn @ 400VAC	Pn @ 500/ 525VAC	Coil V DC	Aux
Operational Current Ie @ 400V AC-3 Duty-9A SIZE S0				
3RT1023-1BB40	4	5.5	24	-
3RT1023-1BF40	4	5.5	110	-
3RT1023-1BM40	4	5.5	220	-
Operational Current Ie @ 400V AC-3 Duty-12A SIZE S0				
3RT1024-1BB40	5.5	7.5	24	-
3RT1024-1BF40	5.5	7.5	110	-
3RT1024-1BM40	5.5	7.5	220	-
Operational Current Ie @ 400V AC-3 Duty-17A SIZE S0				
3RT1025-1BB40	7.5	10	24	-
3RT1025-1BF40	7.5	10	110	-
3RT1025-1BM40	7.5	10	220	-
Operational Current Ie @ 400V AC-3 Duty-25A SIZE S0				
3RT1026-1BB40	11	11	24	-
3RT1026-1BF40	11	11	110	-
3RT1026-1BM40	11	11	220	-
Operational Current Ie @ 400V AC-3 Duty-32A SIZE S2				
3RT1034-1BB40	15	18.5	24	-
3RT1034-1BF40	15	18.5	110	-
3RT1034-1BM40	15	18.5	220	-
Operational Current Ie @ 400V AC-3 Duty-40A SIZE S2				
3RT1035-1BB40	18.5	22	24	-
3RT1035-1BF40	18.5	22	110	-
3RT1035-1BM40	18.5	22	220	-
Operational Current Ie @ 400V AC-3 Duty-50A SIZE S2				
3RT1036-1BB40	22	30	24	-
3RT1036-1BF40	22	30	110	-
3RT1036-1BM40	22	30	220	-
Snap-on auxiliary switch blocks S00				
3RH1911-1FA20	2 or 4-pole		2N/O	
3RH1911-1FA11	2 or 4-pole		1N/O + 1N/C	
3RH1911-1FA02	2 or 4-pole		2N/C	
3RH1911-1FB11	2 or 4-pole		1N/O (lead) + 1N/C (lag)	
3RH1911-1FA40	2 or 4-pole		4N/O	
3RH1911-1FA31	2 or 4-pole		3N/O + 1N/C	
3RH1911-1FA22	2 or 4-pole		2N/O + 2N/C	
Snap-on auxiliary switch blocks S0-S3				
3RH1921-1FA40	4-pole		4N/O	
3RH1921-1FA31	4-pole		3N/O + 1N/C	
3RH1921-1FA22	4-pole		2N/O + 2N/C	
3RH1921-1FA04	4-pole		4N/C	
3RH1921-1LA11	2-pole		1N/O + 1N/C	
3RH1921-1CA01	1-pole		1N/C	
3RH1921-1CA10	1-pole		1N/O	

INDUSTRIAL CONTROLS

Sirius Classic 3RT1 Contractor

Part Number	Description	Details
3RH1921-1DA11		1N/O + 1N/C
3RH1921-1EA20	First laterally mounted, 2 - Pole	2N/O
3RH1921-1EA11		1N/O + 1N/C
3RH1921-1EA02		2N/C

Lateral auxiliary switch blocks S3-S12

3RH1921-1JA11		1N/O + 1N/C
3RH1921-1KA20	Second laterally mounted, 2 - Pole	2N/O
3RH1921-1KA11		1N/O + 1N/C
3RH1921-1KA02		2N/C

Surge suppressors Size S00

3RT1916-1BB00	Varistor - without LED	24-48V(AC) & 24-70V(DC)
3RT1916-1BC00	Varistor - without LED	48-127V(AC) & 70-150V(DC)
3RT1916-1BD00	Varistor - without LED	127-240V(AC) & 150-250V(DC)
3RT1916-1JJ00	Varistor - with LED	24-48V(AC) & 12-24V(DC)
3RT1916-1JK00	Varistor - with LED	48-127V(AC) & 24-70V(DC)
3RT1916-1JL00	Varistor - with LED	127-240V(AC) & 70-150V(DC)
3RT1916-1JP00	Varistor - with LED	150-250V(DC)
3RT1916-1CB00	RC element	48-127V(AC) & 24-70V(DC)
3RT1916-1CC00	RC element	127-240V(AC) & 70-150V(DC)
3RT1916-1CD00	RC element	150-250V(DC)

Surge suppressors Size S0

3RT1926-1BB00	Varistor - without LED	24-48V(AC) & 24-70V(DC)
3RT1926-1BC00	Varistor - without LED	48-127V(AC) & 70-150V(DC)
3RT1926-1BD00	Varistor - without LED	127-240V(AC) & 150-250V(DC)

Surge suppressors Size S2 & S3

3RT1936-1CB00	RC element	24-48V(AC) & 24-70V(DC)
3RT1936-1CC00	RC element	48-127V(AC) & 70-150V(DC)
3RT1936-1CD00	RC element	127-240V(AC) & 150-250V(DC)

Contacts Tips

3RT1934-6A	Main contacts for AC-3, fixed and moving	3RT1034
3RT1935-6A		3RT1035
3RT1936-6A		3RT1036

INDUSTRIAL CONTROLS

Sirius Classic 3RT1 Contractor Accessories

Part Number	Description	Details
-------------	-------------	---------

Coils AC Operation SIZE S0

3RT1924-5AF01	for 3RT1024/ 25	110V
3RT1924-5AP01	for 3RT1024/ 25	220V
3RT1924-5AV01	for 3RT1024/ 25	400V

Coils AC Operation SIZE S2

3RT1934-5AF01	for 3RT1034	110V
3RT1934-5AP01	for 3RT1034	220V
3RT1934-5AV01	for 3RT1034	400V
3RT1935-5AF01	for 3RT1035/36	110V
3RT1935-5AP01	for 3RT1035/36	220V
3RT1935-5AV01	for 3RT1035/36	400V

Coils AC Operation SIZE S3

3RT1944-5AF01	for 3RT1044	110V
3RT1944-5AP01	for 3RT1044	220V
3RT1944-5AV01	for 3RT1044	400V
3RT1945-5AF01	for 3RT1045/46	110V
3RT1945-5AP01	for 3RT1045/46	220V
3RT1945-5AV01	for 3RT1045/46	400V

Reversing contactor assembly kits

3RA1913-2A	Reversing kit: Mechanical interlock, 2 connecting clips for contactors, Wiring	S00 - 3RT101...
3RA1924-2B	Mechanical Interlock	S0-S3
3RA1923-2A	Reversing kit: 2 connecting clips for contactors, Wiring connectors on top &	S0 - 3RT102...
3RA1933-2A	Reversing kit: 2 connecting clips for contactors, Wiring connectors	S2 - 3RT103...

Technical Assistance :

<http://support.automation.siemens.com>

Share Call: 0860 80 80 80 (within RSA)

email: support.south-africa.automation@siemens.com

3RW30/40 Soft Starters - Standard Applications

Application Examples for Normal Starting (CLASS 10)

Application	Conveyor belt	Roller conveyor	Compressor	Small fans ¹⁾	Pump	Hydraulic pump
Starting parameters						
• Voltage ramp and current limiting						
- Starting voltage	% 70	60	50	40	40	40
- Starting time	s 10	10	10	10	10	10
- Current limit value	$5 \times I_M$	$5 \times I_M$	$4 \times I_M$	$4 \times I_M$	$4 \times I_M$	$4 \times I_M$
Ramp-down time	s 5	5	0	0	10	0

¹⁾ The mass inertia of the fan is <10 times the mass inertia of the motor.

Application Examples for heavy Starting (CLASS 20)

Heavy starting CLASS 20 (up to 40 s with 350 % I_n motor)

The soft starter has to be selected at least one performance class higher than the motor used.

Application	Stirrer	Centrifuge
Starting parameters		
• Voltage ramp and current limiting		
- Starting voltage	% 40	40
- Starting time	s 20	20
- Current limit value	$4 \times I_M$	$4 \times I_M$
Ramp-down time	0	0



Technical Assistance :

<http://support.automation.siemens.com>

Share Call: 0860 80 80 80 (within RSA)

email: support.south-africa.automation@siemens.com

3RW44 Soft Starters - High Feature

Application Examples for heavy Starting (CLASS 30)

Very heavy starting CLASS 30 (up to 60 s with 350 % $I_{n,motgr}$)

The soft starter has to be selected two performance classes higher than the motor used

Application	Large fans ²⁾	Mills	Breakers	Circular saws/bar
Starting parameters				
• Voltage ramp and current limiting				
- Starting voltage	30 %	50	50	30
- Starting time	60 s	60	60	60
- Current limit value	4 x I_M	4 x I_M	4 x I_M	4 x I_M
• Torque ramp				
- Starting torque	20	50	50	20
- End torque	150	150	150	150
- Starting time	60	60	60	60
• Breakaway pulse				
	Deactivated (0 ms)	80 %; 300 ms	80 %; 300 ms	Deactivated (0 ms)
Ramp-down mode				
	Free ramp-down	Free ramp-down	Free ramp-down	Free ramp-down

¹⁾ The mass inertia of the fan is <10 times the mass inertia of the motor.

²⁾ The mass inertia of the fan is ≥ 10 times the mass inertia of the motor.



Note:

These tables present sample set values and device sizes. They are intended only for the purposes of information and are not binding. The set values depend and must be optimized during commissioning. The soft starter dimensions are determined with the Win-Soft Starter software or with the help of Technical Assistance.

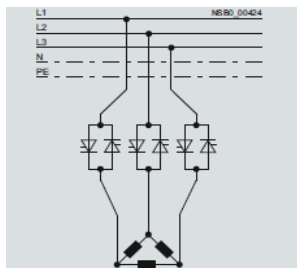

Inline circuit:

Rated current I_e corresponds to the rated motor current I_n , 3 cables to the motor

INDUSTRIAL CONTROLS

3RW30/40 Soft Starters Standard Application, Derate According To Class

Part Number	Rated VAC	Rated Ie (A)	kW @ 400v	kW @ 500v	Rated control supply voltage
NB!!!!Note: The overload protection, must be added separately to the 3RW30					
3RW3013-1BB14		3.6	1.5		110/230VAC
3RW3014-1BB14	200-480 VAC	6.5	3		110/230VAC
3RW3016-1BB14		9	4		110/230VAC

3RW40 Softstarters for 3-phase asynchronous motors @ amb temp. 40 °C - class 10

Soft Starting / stopping	Motor overload protection
Voltage Ramp	Selectable current limiting
Intergrated bypass contacts	2 controlled phases
Intrinsic device protection	Screw terminals

3RW4024-1BB_4		12.5	5.5	-
3RW4026-1BB_4		25	11	-
3RW4027-1BB_4		32	15	-
3RW4028-1BB_4		38	18.5	-
3RW4036-1BB_4	200-480 VAC	45	22	-
3RW4037-1BB_4		63	30	-
3RW4038-1BB_4		72	37	-
3RW4046-1BB_4		80	45	-
3RW4047-1BB_4		106	55	-



Rated control supply voltage	
0	24VAC/DC
1	110/230VAC

3RW4055-6BB_4		134	75	-
3RW4056-6BB_4		162	90	-
3RW4073-6BB_4	200-480 VAC	230	132	-
3RW4074-6BB_4		280	160	-
3RW4075-6BB_4		356	200	-
3RW4076-6BB_4		432	250	-



3RW4055-6BB_5		134	75	90
3RW4056-6BB_5		162	90	110
3RW4073-6BB_5	400-600 VAC	230	132	160
3RW4074-6BB_5		280	160	200
3RW4075-6BB_5		356	200	250
3RW4076-6BB_5		432	250	315



Rated control supply voltage	
3	110VAC
4	230VAC

INDUSTRIAL CONTROLS

3RW44 Soft Starters Application, Derate According To Class

Part Number	Rated VAC	Rated Ie (A)	kW @ 400v	kW @ 500v	Rated control supply voltage
-------------	-----------	--------------	-----------	-----------	------------------------------

Product Features 3RW44 :

Soft Starting / stopping
Voltage Ramp
Intergrated bypass contacts
Intrinsic device protection
Breakaway Pulse
Pump Stopping
Motor heating

Motor overload protection
Selectable current limiting
3 controlled phases
Programmable I/O
Inside-delta circuit configuration
LCD Display
Heavy duty starting

3RW44 Softstarters for 3-phase asynchronous motors @ ambient temp. 40 °C

3RW4422-1BC_4		29	15	-
3RW4423-1BC_4		36	18.5	-
3RW4424-1BC_4		47	22	-
3RW4425-1BC_4		57	30	-
3RW4426-1BC_4		77	37	-
3RW4427-1BC_4		93	45	-
3RW4434-6BC_4	200-460	113	55	-
3RW4435-6BC_4		134	75	-
3RW4436-6BC_4		162	90	-
3RW4443-6BC_4		203	110	-
3RW4444-6BC_4		250	132	-
3RW4445-6BC_4		313	160	-
3RW4446-6BC_4		356	200	-
3RW4447-6BC_4		432	250	-



Rated control supply voltage

3	110VAC
4	230VAC

3RW4422-1BC_5		29	15	18.5
3RW4423-1BC_5		36	18.5	22
3RW4424-1BC_5		47	22	30
3RW4425-1BC_5		57	30	37
3RW4426-1BC_5		77	37	45
3RW4427-1BC_5		93	45	55
3RW4434-6BC_5	400-600	113	55	75
3RW4435-6BC_5		134	75	90
3RW4436-6BC_5		162	90	110
3RW4443-6BC_5		203	110	132
3RW4444-6BC_5		250	132	160
3RW4445-6BC_5		313	160	200
3RW4446-6BC_5		356	200	250
3RW4447-6BC_5		432	250	315



Rated control supply voltage

3	110VAC
4	230VAC



NOTE!!! 3RW44 rated 690VAC, please contact technical support

3RW44 Accessories

Part Number

Description

Soft Starter ES 2007 PC communication program

3ZS1313-4CC10-0YA5

Soft Starter ES 2007 Basic

3ZS1313-5CC10-0YA5

Soft Starter ES 2007 Standard

3ZS1313-6CC10-0YA5

Soft Starter ES 2007 Premium, communication through system interface PROFIBUS/PROFINET

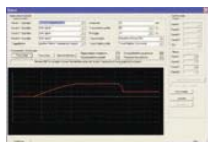

SIRIUS 3RW44 Soft Starter block library for SIMATIC PCS 7



3ZS1633-1XX00-0YA0

PCS 7 process control system, for PCS 7, version V 6.1/V 7.0

3ZS1633-2XX00-0YB0

Runtime software

PC cables

3UF7941-0AA00-0

USB, PC/PG communication with SIRIUS 3RW44 soft starters



Communication modules

3RW4900-0KC00

Optional PROFIBUS communication modules

3RW4900-0NC00

Optional PROFINET communication modules



External display and operator module

3RW4900-0AC00

externally mounted display and operator

3UF7933-0BA00-0

Connection cable, length 2.5 m, round

3RW44 Soft Starters - High Feature

Motor feeders with 3RW40 soft starters

Soft starters Q11 Type	Nominal current A	Motor starter protectors ¹⁾			
		400 V + 10 % Q1 Type	400 V + 10 % Q1 Type	$I_{q \max}$ kA	Rated current A
Type of coordination *1"					
3RW4024	12.5	3RV2021-4AA/ 3RV2011-4AA (in size S00)	3RV2321-4AC/ 3RV2311-4AC (in size S00)	55	16
3RW4026	25	3RV2021-4DA	3RV2321-4DC	55	25
3RW4027	32	3RV2021-4EA	3RV2321-4EC	55	32
3RW4028	38	3RV2021-4FA	3RV2321-4FC	55	40
3RW4036	45	3RV1031-4GA10	3RV1331-4GC10	20	45
3RW4037	63	3RV1041-4JA10	3RV1341-4JC10	20	63
3RW4038	72	3RV1041-4KA10	3RV1341-4KC10	20	75
3RW4046	80	3RV1041-4LA10	3RV1341-4LC10	11	90
3RW4047	106	3RV1041-4MA10	3RV1341-4MC10	11	100
3RW4055	134	3VL3720-2DC36	--	35	200
3RW4056	162	3VL3720-2DC36	--	35	200
3RW4073	230	3VL4731-2DC36	--	65	315
3RW4074	280	3VL4731-2DC36	--	65	315
3RW4075	356	3VL4740-2DC36	--	65	400
3RW4076	432	3VL5750-2DC36	--	65	500

Motor feeders with 3RW44 soft starters

Soft starters Q11 Type	Nominal current A	Motor starter protectors ¹⁾	
		440 V + 10 % Q1 Type	Rated current A
Type of coordination *1": 3RW4422 ... 3RW4427: $I_{q} = 32$ kA; 3RW44			
3RW4422	29	3RV1042-4HA10	50
3RW4423	36	3RV1042-4JA10	63
3RW4424	47	3RV1042-4KA10	75
3RW4425	57	3RV1042-4LA10	90
3RW4426	77	3RV1042-4MA10	100
3RW4427	93	3RV1042-4MA10	100
3RW4434	113	3VL1716-2DD36	160
3RW4435	134	3VL1716-2DD36	160
3RW4436	162	3VL3725-2DC36	250
3RW4443	203	3VL4731-3DC36	315
3RW4444	250	3VL4731-3DC36	315
3RW4445	313	3VL4740-3DC36	400
3RW4446	356	3VL4740-3DC36	400
3RW4447	432	3VL5750-3DC36	500
3RW4453	551	3VL6780-3SB36	800
3RW4454	615	3VL6780-3SB36	800
3RW4455	693	3VL6780-3SB36	800
3RW4456	780	3VL7710-3SB36	1 000
3RW4457	880	3VL7710-3SB36	1 000
3RW4458	970	3VL7712-3SB36	1 250
3RW4465	1 076	3VL7712-3SB36	1 250
3RW4466	1 214	3VL7712-3SB36	1 250

3RW44 Accessories

3RW40 Fused version with 3NE1 SITOR fuses

Soft starters T _{OC} 2 Q11 Type	Nominal current A	All-range fuses		
		F1 Type	Rated current A	Size
Type of coordination *2¹⁾: $I_q = 65 \text{ kA at } 600 \text{ V} + 5 \%$				
3RW4024	12.5	3NE1814-0	20	000
3RW4026	25	3NE1803-0	35	000
3RW4027	32	3NE1020-2	80	00
3RW4028	38	3NE1020-2	80	00
3RW4036	45	3NE1020-2	80	00
3RW4037	63	3NE1820-0	80	000
3RW4038	72	3NE1820-0	80	000
3RW4046	80	3NE1021-0	100	00
3RW4047	106	3NE1022-0	125	00
3RW4055	134	3NE1227-2	250	1
3RW4056	162	3NE1227-2	250	1
3RW4073	230	3NE1331-2	350	2
3RW4074	280	3NE1333-2	450	2
3RW4075	356	3NE1334-2	500	2
3RW4076	432	3NE1435-2	560	3

3RW44 Fused version with 3NE1 SITOR fuses

Soft starters T _{OC} 2 Q11 Type	Nominal current A	All-range fuses	
		F1 Type	Rated current A
Type of coordination 2³⁾: $I_q = 65 \text{ kA}$			
3RW4422	29	3NE1020-2	80
3RW4423	36	3NE1020-2	80
3RW4424	47	3NE1021-2	100
3RW4425	57	3NE1022-2	125
3RW4426	77	3NE1022-2	125
3RW4427	93	3NE1224-2	160
3RW4434	113	3NE1225-2	200
3RW4435	134	3NE1227-2	250
3RW4436	162	3NE1227-2	250
3RW4443	203	3NE1230-2	315
3RW4444	250	3NE1331-2	350
3RW4445	313	3NE1333-2	450
3RW4446	356	3NE1334-2	500
3RW4447	432	3NE1435-2	560
3RW4453	551	2 x 3NE1334-2	500
3RW4454	615	2 x 3NE1334-2	500
3RW4455	693	2 x 3NE1334-2	500
3RW4456	780	2 x 3NE1435-2	560
3RW4457	880	2 x 3NE1435-2	560
3RW4458	970	2 x 3NE1435-2	560
3RW4465	1 076	3 x 3NE1334-2	500
3RW4466	1 214	3 x 3NE1435-2	560

SIRIUS Innovations 3RU2 Thermal Overloads - Class 10

Part Number	Rated I(A)	Description	Size
S00 - Thermal overload Class 10			
3RU2116-0AB0	0.11 - 0.16	Overload and phase failure protection, 1NO+1NC Aux, Manual and automatic RESET, TEST function, STOP button, Switch position indicator	SIZE S00
3RU2116-0BB0	0.14 - 0.2		
3RU2116-0CB0	0.18 - 0.25		
3RU2116-0DB0	0.22 - 0.32		
3RU2116-0EB0	0.28 - 0.4		
3RU2116-0FB0	0.35 - 0.5		
3RU2116-0GB0	0.45 - 0.63		
3RU2116-0HB0	0.55 - 0.8		
3RU2116-0JB0	0.7 - 1		
3RU2116-0KB0	0.9 - 1.25		
3RU2116-1AB0	1.1 - 1.6		
3RU2116-1BB0	1.4 - 2		
3RU2116-1CB0	1.8 - 2.5		
3RU2116-1DB0	2.2 - 3.2		
3RU2116-1EB0	2.8 - 4		
3RU2116-1FB0	3.5 - 5		
3RU2116-1GB0	4.5 - 6.3		
3RU2116-1HB0	5.5 - 8		
3RU2116-1JB0	7 - 10		
3RU2116-1KB0	9 - 12.5		
3RU2116-4AB0	11 - 16		



S0 - Thermal overload Class 10

3RU2126-1CB0	1.8 - 2.5	Overload and phase failure protection, 1NO+1NC Aux, Manual and automatic RESET, TEST function, STOP button, Switch position indicator	SIZE S0
3RU2126-1DB0	2.2 - 3.2		
3RU2126-1EB0	2.8 - 4		
3RU2126-1FB0	3.5 - 5		
3RU2126-1GB0	4.5 - 6.3		
3RU2126-1HB0	5.5 - 8		
3RU2126-1JB0	7 - 10		
3RU2126-1KB0	9 - 12.5		
3RU2126-4AB0	11 - 16		
3RU2126-4BB0	14 - 20		
3RU2126-4CB0	17 - 22		
3RU2126-4DB0	20 - 25		
3RU2126-4NB0	23 - 28		
3RU2126-4EB0	27 - 32		
3RU2126-4PB0	30 - 36		
3RU2126-4FB0	34 - 40		



S2 - Thermal overload Class 10

3RU2136-4GB0	36 - 45	Overload and phase failure protection, 1NO+1NC Aux, Manual and automatic RESET, TEST function, STOP button, Switch position indicator	SIZE S2
3RU2136-4HB0	40 - 50		
3RU2136-4QB0	47 - 57		
3RU2136-4JB0	54 - 65		
3RU2136-4KB0	62 - 73		
3RU2136-4RB0	70 - 80		



S2 - Thermal overload Class 10

3RU1146-4HB0	36 - 50	Overload and phase failure protection, 1NO+1NC Aux, Manual and automatic RESET, TEST function, STOP button, Switch position indicator	SIZE S3
3RU1146-4JB0	45 - 63		
3RU1146-4KB0	57 - 75		
3RU1146-4LB0	70 - 90		
3RU1146-4MB0	80 - 100		



Technical Assistance :

<http://support.automation.siemens.com>

Share Call: 0860 80 80 80 (within RSA)

email: support.south-africa.automation@siemens.com

INDUSTRIAL CONTROLS

SIRIUS Innovations 3RB30 & 3RB31 Size S00 - S2 Solid State - Class 10 and 3RB2 Up To 630A

Part Number	Rated I(A)	Description	Size	More Options available on request
S00 - Solid-State overload Class 10				
3RB3016-1RB0	0.1 - 0.4	Overload protection, phase failure protection and unbalance protection, 1NO+1NC Aux, Manual and automatic RESET, Internal power supply	SIZE S00	
3RB3016-1NB0	0.32 - 1.25			
3RB3016-1PB0	1 - 4			
3RB3016-1SB0	3 - 12			
3RB3016-1TB0	4 - 16			

Part Number	Rated I(A)	Description	Size	More Options available on request
S0 - Solid-State overload Class 10				
3RB3026-1RB0	0.1 - 0.4	Overload protection, phase failure protection and unbalance protection, 1NO+1NC Aux, Manual and automatic RESET, Internal power supply	SIZE S0	
3RB3026-1NB0	0.32 - 1.25			
3RB3026-1PB0	1 - 4			
3RB3026-1SB0	3 - 12			
3RB3026-1QB0	6 - 25			
3RB3026-1VB0	10 - 40			

Part Number	Rated I(A)	Description	Size	More Options available on request
S2 - Solid-State overload Class 10				
3RB3036-1UB0	12.5 - 50	Overload protection, phase failure protection and unbalance protection, 1NO+1NC Aux, Manual and automatic RESET, Internal power supply	SIZE S2	
3RB3036-1WB0	20 - 80			
Direct Mounting onto S2 3RT2 contactor				

Part Number	Rated I(A)	Description	Size	More Options available on request
3RB3036-1UW1	12.5 - 50	Overload protection, phase failure protection and unbalance protection, 1NO+1NC Aux, Manual and automatic RESET, Internal power supply	SIZE S2	
3RB3036-1WW1	20 - 80			
Stand alone installation				









Part Number	Rated I(A)	Description	Size	More Options available on request
S3 - Solid-State overload Class 10				
3RB2046-1UB0	12.5 - 50	3RB20 electronic overload relays for mounting onto contactors	SIZE S3	
3RB2046-1EB0	25 - 100			
3RB2046-1EW1	25 - 100		SIZE S3	

Part Number	Rated I(A)	Description	Size	More Options available on request
S6 - Solid-State overload Class 10				
3RB2056-1FC2	50-200	3RB20 electronic overload relays for mounting onto contactors	SIZE S6	
3RB2056-1FW2	50-200			
3RB20 Devices with straight-through transformer, for stand-alone installation				

Part Number	Rated I(A)	Description	Size	More Options available on request
S10 - Solid-State overload Class 10				
3RB2066-1GC2	55 - 250	3RB20 Devices with busbar connection for stand-alone installation	SIZE S10	
3RB2066-1MC2	160 - 630			
3RB20 Devices with busbar connection for stand-alone installation				

Features	3RU21	3RU11	3RB30/3RB31	3RB20/3RB21	3RB22/3RB23	3RB24
General data						
Size	S00 ... S2	S3	S00 ... S2	S3 ... S12	S00 ... S12	S00 ... S12
Seamless current range	0.11 - 80 A	18 ... 100 A	0.1 - 80 A	12.5 - 630 A	0.3 - 630 A (up to 820 A) ¹⁾	0.3 - 630 A (up to 620 A) ¹⁾

3RB22 Electronic Overload. 3RU2/3RB2 Accessories

Part Number	Rated I(A)	Description	Size	
EVALUATION MODULE				
3RB2283-4AA1		Monostable, size of conatctor S00-S12		 3RB2283-4AA1, 3RB2383-4AA1
Current measuring module				
3RB2906-2BG1	0,3 - 3	Devices with straight-through transformer, for stand-alone installation		 3RB2906-2BG1, 3RB2906-2DG1
3RB2906-2DG1	2,4 - 25			
3RB2906-2JG1	10-100			
3RB2956-2TH2	10 - 100	Devices with busbar connection, for mounting onto contactor and stand-alone installation		 3RB2956-2BG1, 3RB2906-2DG1
3RB2956-2TG2	20 - 200	Devices with straight-through transformer, for mounting onto contactor and stand-alone installation		
3RB2906-2JG1	63 - 630	Devices with busbar connection, for mounting onto contactor and stand-alone installation		 3RB2966-2WH2
Function expansion modules				
3RB2985-2AA0		Analog Basic 1 modules, ouput 4...20mA DC		 3RB2985-2..1
3RB2985-2AA1		Analog Basic 1 GF modules, ouput 4...20mA DC		
3RB2985-2AB1		Analog Basic 2 GF modules, ouput 4...20mA DC		
3RB2985-2CA1		Analog Basic 1 modules, with gorund fault detection		
3RB2985-2CB1		Analog Basic 2 GF modules, gorund fault detection		
Connecting Cable				
3RB2987-2B		For connection between evaluation module, Length 0.1 m and current measuring module		 3RB2987-2
3RB2987-2D		For connection between evaluation module, Length 0.5 m and current measuring module		
3RU2/3RB3/3RR Accessories				
Part Number		Description	Size	
3RU2916-3AA01		Base for separate mounting of overload with screw terminals	S00	 3RU2916-3AA01
3RU2926-3AA01			S0	
3RU2936-3AA01			S2	
3RU2900-1A		Resetting plungers, holders and formers	S00 ... S2	
3SB3000-0EA11		Pushbuttons with extended stroke		
3SX1335		Extension plungers		
3RU2900-1B		Cable reset - 400mm	S00 ... S2	
3RU2900-1C		Cable reset - 600mm	S00 ... S2	
3RU1900-2AB71		Remote reset module, 24 - 30V AC/DC	S00 ... S2	 3RU1900-2A.71
3RU1900-2AF71		Remote reset module, 110 - 127 V AC/DC	S00 ... S2	
3RU1900-2AM71		Remote reset module, 220 - 250V AC/DC	S00 ... S2	

SIRIUS Classic 3RU1 Size S00 - S2 Thermal Overloads -Class 10

Part Number	Pn @ 400V 50Hz	Thermal Current Range Setting
Manual/ Automatic reset, Switch position indicator, Auxiliary contacts 1N/O+1N/C size S00		
3RU1116-0AB0	0.04	0.11-0.16
3RU1116-0BB0	0.06	0.14-0.2
3RU1116-0CB0	0.06	0.18-0.25
3RU1116-0DB0	0.09	0.22-0.32
3RU1116-0EB0	0.09	0.28-0.4
3RU1116-0FB0	0.12	0.35-0.5
3RU1116-0GB0	0.18	0.45-0.63
3RU1116-0HB0	0.18	0.55-0.8
3RU1116-0JB0	0.25	0.7-1
3RU1116-0KB0	0.37	0.9-1.25
3RU1116-1AB0	0.55	1.1-1.6
3RU1116-1BB0	0.75	1.4-2
3RU1116-1CB0	0.75	1.8-2.5
3RU1116-1DB0	1.1	2.2-3.2
3RU1116-1EB0	1.5	2.8-4
3RU1116-1FB0	1.5	3.5-5
3RU1116-1GB0	2.2	4.5-6.3
3RU1116-1HB0	3	5.5-8
3RU1116-1JB0	4	7-10
3RU1116-1KB0	5.5	9-12



size S0		
3RU1126-1CB0	0.75	1.8-2.5
3RU1126-1DB0	1.1	2.2-3.2
3RU1126-1EB0	1.5	2.8-4
3RU1126-1FB0	1.5	3.5-5
3RU1126-1GB0	2.2	4.5-6.3
3RU1126-1HB0	3	5.5-8
3RU1126-1JB0	4	7-10
3RU1126-1KB0	5.5	9-12.5
3RU1126-4AB0	7.5	11-16
3RU1126-4BB0	7.5	14-20
3RU1126-4CB0	11	17-22
3RU1126-4DB0	11	20-25



size S2		
3RU1136-1HB0	3	5.5-8
3RU1136-1JB0	4	7-10
3RU1136-1KB0	5.5	9-12.5
3RU1136-4AB0	7.5	11-16
3RU1136-4BB0	7.5	14-20
3RU1136-4DB0	11	18-25
3RU1136-4EB0	15	22-32
3RU1136-4FB0	18.5	28-40
3RU1136-4GB0	22	36-45
3RU1136-4HB0	22	40-50



Adapter for installing as a single unit : 3RU Thermal Overloads

3RU1916-3AA01	Separate mounting unit - 3RU1116	S00
3RU1926-3AA01	Separate mounting unit - 3RU1126	S0
3RU1936-3AA01	Separate mounting unit - 3RU1136	S2



INDUSTRIAL CONTROLS

SIMOCODE Pro 3UF7 Motor Management and Control Devices

Part Number	Description	Width mm
SIMOCODE Pro 3UF7020-1AB01-0	SIMOCODE Pro S basic unit, 24 V DC	
3UF7020-1AU01-0	SIMOCODE Pro S basic unit, 110 ... 240 V AC/DC	
3UF7010-1AB00-0	SIMOCODE Pro V PB , basic unit 2, 24 V DC	
3UF7010-1AU00-0	SIMOCODE Pro V PB , basic unit 2, 110 ... 240 V AC/DC	
3UF7011-1AB00-0	SIMOCODE Pro V PN , basic unit 2, 24 V DC	
3UF7011-1AU00-0	SIMOCODE Pro V PN , basic unit 2, 110 ... 240 V AC/DC	
Current measuring modules		
3UF7100-1AA00-0	0.3 ... 3	45
3UF7101-1AA00-0	2.4 ... 25	45
3UF7102-1AA00-0	10 ... 100	55
3UF7103-1AA00-0	20 ... 200	120
3UF7103-1BA00-0	20 ... 200 Busbar	120
3UF7104-1BA00-0	63 ... 630 Busbar	145
Current/Voltage measuring modules		
3UF7110-1AA00-0	0.3 ... 3	45
3UF7111-1AA00-0	2.4 ... 25	45
3UF7112-1AA00-0	10 ... 100	55
3UF7113-1AA00-0	20 ... 200	120
3UF7113-1BA00-0	20 ... 200 Busbar	120
3UF7114-1BA00-0	63 ... 630 Busbar	145
Operator Panels		
3UF7200-1AA00-0	BASIC PERATOR PANEL; 10 LEDS FOR STATUS DISPLAY AND 5 USER-ASSIGNABLE KEYS FOR MANUAL CONTROL	
3UF7200-1AA01-0	BASIC PERATOR PANEL (Titanium gray); 10 LEDS FOR STATUS DISPLAY AND 5 USER-ASSIGNABLE KEYS FOR MANUAL CONTROL	
3UF7210-1AA00-0	Operator panel with display for SIMOCODE pro V, 7 LEDs for status indication and user-assignable buttons for controlling the motor, multilingual display	



SIMOCODE Pro 3UF7 Motor Management and Control Devices

Part Number Relay Outputs Input V

Expansion Modules

Digital Modules

4 binary inputs & 2 relay outputs, up to 2 DM's can be connected per basic unit 2.

3UF7300-1AB00-0 Monostable 24V DC

3UF7300-1AU00-0 Monostable 110 ... 240V DC/AC

Analog Modules

2 inputs (passive) for input & 1 output 0/4 ... 20mA signals. Max. 1 analog module can be connected per basic unit 2.

3UF7400-1AA00-0

Ground Fault Modules

1 input for connecting a 3UL22 summation current transformer (see page ?), up to 1 ground fault module can be connected per basic unit 2.

3UF7510-1AA00-0 (Only for use with 3UL23 Cumtation CT's)

Temperature Modules

3 inputs for connecting up to 3 analog temp sensors (PT100, PT1000, KTY84, KTY85 or NTC's, up to 1 temp module can be connected per basic unit 2.

3UF7700-1AA00-0

Decoupling Modules

For connecting upstream from a current/voltage measuring module on the system interface when using voltage detection in non-grounded networks.

3UF7150-1AA00-0

Multifunction modules for Pro S

4 I/P & 2 RELAY O/P; RESIDUAL CURRENT DETECTION WITH 3UL23; TEMPERATURE SENSOR PT100/PT1000/KTY/NTC

3UF7600-1AB01-0 24 V DC

3UF7600-1AU01-0 110 ... 240 V AC/DC

DM-F Local fail-safe digital modules

FAIL-SAFE DIGITAL MODULE DM-F LOCAL; FOR FAIL-SAFE SWITCH-OFF VIA HARDWARE SIGNAL; UV: 24 V DC, 2 RELAY ENABLING CIRCUITS; 2 RELAY OUTPUTS; SAFETY FUNCTION CAN BE SELECTED VIA DIL SWITCH; MAX. ERR. SIL (IEC 61508): 3; MAX. ERR. PL (ISO 13849-1): E;

3UF7320-1AB00-0 24 V DC

3UF7320-1AU00-0 110 ... 240 V AC/DC

DM-F PROFIsafe fail-safe digital modules

FAIL-SAFE DIGITAL MODULE DM-F LOCAL; FOR FAIL-SAFE SWITCH-OFF PROFIBUS/PROFIsafe or PROFINET/PROFIsafe; UV: 24 V DC, 2 RELAY ENABLING CIRCUITS; 2 RELAY OUTPUTS; SAFETY FUNCTION CAN BE SELECTED VIA DIL SWITCH; MAX. ERR. SIL (IEC 61508): 3; MAX. ERR. PL (ISO 13849-1): E;

3UF7330-1AB00-0 24 V DC

3UF7330-1AU00-0 110 ... 240 V AC/DC



SIMOCODE Pro 3UF7 Motor Management and Control Devices

Connection cables (essential accessory)

In different lengths for connecting basic unit, current, current/voltage measuring module, operator panel or expansion modules

Part Number	Length
3UF7930-0AA00-0	0.025m (flat)
3UF7931-0AA00-0	0.1m (flat)
3UF7935-0AA00-0	0.3m (flat)
3UF7932-0BA00-0	0.5m (round)
3UF7937-0BA00-0	1.0m (round)
3UF7933-0BA00-0	2.5m (round)



PC cables

3UF7941-0AA00-0	USB PC Programming cable
-----------------	--------------------------



Memory Module

3UF7900-0AA00-0

For parameterizing SIMOCODE pro without a PC/PG

The memory module enables the complete parameter assignment of a system to be saved and transferred to a new system e.g. when a device is replaced, without the need for additional aids or detailed knowledge of the system interface



Addressing Plug

3UF7910-0AA00-0

For assigning the PROFIBUS address without a PC/PG on SIMOCODE pro through the system interface



Door Adaptor

3UF7920-0AA00-0

For external connection of the system interface outside, for example, a control cabinet



Adaptors for Operator Panels

3UF7922-0AA00-0

The adaptor enables the smaller 3UF720 operator panel from SIMOCODE pro to be used in a front panel cutout in which previously, e.g. after a change of system, a larger 3UF52 operator panel from SIMOCODE-DP had been used. **IP54**



Additional Current Transformers

3UF1868-3GA00	205 ... 820A
---------------	--------------

For mounting onto contactors and stand-alone installations

See technical data for wiring diagram



SIMOCODE Pro 3UF7 Motor Management and Control Devices

Part Number	Rated Fault Current A	Width mm	Rec Motor Sizes
Summation Current Transformer - 3UL23 only as spares to be used with 3UF7510... Earth fault module			
3UL2302-1A	30mA to 40A	35	upto 85A
3UL2303-1A	30mA to 40A	55	upto 150A
3UL2304-1A	30mA to 40A	80	upto 225A
3UL2305-1A	30mA to 40A	110	upto 400A
3UL2306-1A	30mA to 40A	140	upto 500A
3UL2307-1A	30mA to 40A	210	upto 630A



New- only use with 3UF7510 ...

Accessories for motor control center

3UF7902-0AA00-0 INITIALIZATION MODULE FOR AUTOM. PARAMETERIZATION OF SIMOCODE



3UF7931-0CA00-0 Y CONNECTION CABLE 0.1M / 1.0M

3UF7932-0CA00-0 Y CONNECTION CABLE 0.5M / 1.0M

3UF7937-0CA00-0 Y CONNECTION CABLE 1.0M / 1.0M

Bus connection terminals for Pro S

3UF7960-0AA00-0
BUS TERMINAL FOR CONNECTING A PROFIBUS CABLE TO A SIMOCODE PRO S



SIMOCODE ES Software

3ZS1312-4CC10-0YA5 SIMOCODE ES 2007 Basic Floating License for one user - License key on USB stick, Class A

3ZS1312-5CC10-0YA5 SIMOCODE ES 2007 Standard Floating License for one user - License key on USB stick, Class A

3ZS1312-6CC10-0YA5 SIMOCODE ES 2007 Premium Floating License for one user - License key on USB stick, Class A

SIMOCODE ES (TIA Portal)

3ZS1322-6CC11-0YA5 SIMOCODE ES V13 PREMIUM FLOATING LICENSE F. ONE USER E-SW, SW AND DOCU ON DVD/COMBO LICENSE FOR PARALLEL USE OF SIMOCODE ES 2007 AND V13; LICENSE KEY ON USB stick, Class A

LOW VOLTAGE POWER DISTRIBUTION

Sentron PAC 3200 Power Monitoring Device Accessories

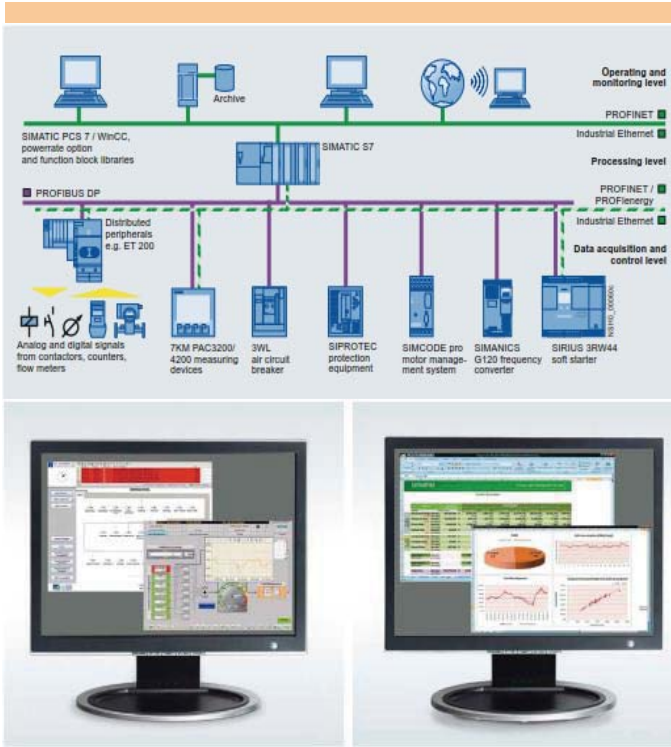

Technical Assistance :

<http://support.automation.siemens.com>

Share Call: 0860 80 80 80 (within RSA)

email: support.south-africa.automation@siemens.com

LOW VOLTAGE POWER DISTRIBUTION

Sentron PAC 3200 Power Monitoring Device Accessories

Part Number	Aux	Main	Connections
7KM3133-0BA00-3AA0	110-220v	Up to 480v	Screw

PAC 3100



Part Number	Aux	Main	Connections
7KM2112-0BA00-3AA0	110-220V	Up to 690v	Screw
7KM2111-1BA00-3AA0	22-65V DC	Up to 500v	Screw
7KM2112-0BA00-2AA0	110-220V	Up to 690v	Ring lug

PAC 3200



Part Number	Aux	Main	Connections
With Harmonic Measurement			
7KM4212-0BA00-3AA0	110-220v	Up to 690v	Screw
7KM4211-1BA00-3AA0	22-65V DC	Up to 500v	Screw
7KM4212-0BA00-2AA0	110-220V	Up to 690v	Ring lug

PAC 4200



Note:

Onboard Ethernet Port as standard



LOW VOLTAGE POWER DISTRIBUTION

Sentron PAC 3200 Power Monitoring Device Accessories

Plug In Communication Modules

Part Number

7KM9300-0AB01-0AA0

Profibus Module

7KM9300-0AM00-0AA0

Modbus Module

7KM9300-0AE01-0AA0

Profinet Module

Modules



7KM9300-0AE01-0AA0

3KC ATC5300 transfer control devices

Part Number

Description

3KC9000-8TL30

ATC5300 transfer control devices

3KC9000-8TL70

ATC5300 software



3KC9000-8TL30



3KC9000-8TL70

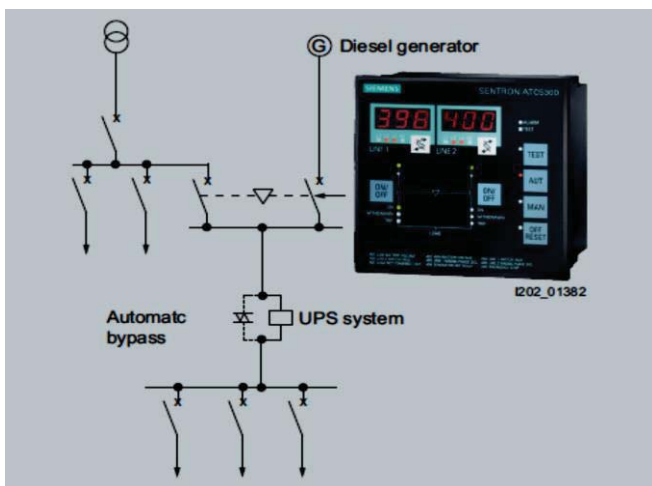

Actuator Sensor Interface

Part Number

Description

Masters for the SIMATIC Spec V3.0

3RK7243-2AA30-0XB0	CM 1243-2 for S7-1200 AS-i
6GK7343-2AH11-0XA0	CP 343-2P for S7-300 and ET 200M
3RK7137-6SA00-0BC1	CM AS-i Master ST for ET 200SP



Routers (Gateways) Spec V3.0

6GK1415-2BA10	DP/AS-i LINK Advanced, single master
6GK1415-2BA20	DP/AS-i LINK Advanced, double master
6GK1415-2AA10	DP/AS-Interface Link 20E
6GK1411-2AB10	IE/AS-i LINK PN IO, single master
6GK1411-2AB20	IE/AS-i LINK PN IO, double master



AS-i power supply units, w. intergr. Ground fault detect

3RX9501-0BA00	3A, 120/230 V AC (selectable)
3RX9502-0BA00	5A, 120/230 V AC (selectable)
3RX9503-0BA00	8A, 120/230 ... 500 V AC(selectable)



AS-Interface shaped cables yellow

3RX9010-0AA00	rubber, 100m roll
3RX9012-0AA00	rubber, 1km roll
3RX9013-0AA00	TPE, 100m roll
3RX9014-0AA00	TPE, 1km roll

AS-Interface shaped cables black 24VDC

3RX9020-0AA00	rubber, 100m roll
3RX9022-0AA00	rubber, 1km roll
3RX9023-0AA00	TPE, 100m roll
3RX9024-0AA00	TPE, 1km roll



Cable terminating pieces

3RK1901-1MN00	For sealing of open cable ends, IP67
----------------------	--------------------------------------



Acuator Sensor Interface

Part Number

Description

SlimLine S22.5 modules Inputs: PNP transistor w-22.5mm

3RK1200-0CE00-0AA2	4I,Standard, 2-wire
3RK1200-0CE02-0AA2	4I,Standard, 2and3 -wire
3RK2200-0CE02-0AA2	4I,A/B, 2and3 -wire
3RK1400-0BE00-0AA2	2I/2 O standard, 2-wire, 2A
3RK1402-0BE00-0AA2	2I/2O standard, 2-wire, 2A relay
3RK1100-1CE00-0AA2	4O standard, 2-wire, 2A



SlimLine S45 modules: Inputs: PNP transistor w-45mm

3RK1400-1CE00-0AA2	4I/4O,Standard, 2-wire, 1A
3RK1400-1CE01-0AA2	4I/4O,Standard, 2and3 -wire, 2A
3RK1402-3CE00-0AA2	4I/4O,Standard, 2and3 -wire,relays
3RK2400-1CE01-0AA2	4I/4O,A/B 2and3 -wire, 2A



Slaves/I/O modules for use in the control cabinet

3RK1400-0CE00-0AA3	4 inputs/4 outputs 200 mA for all I/Os
---------------------------	--



Modules with special functions

3RK1200-0CE03-0AA2	Counter modules
3RK1408-8KE00-0AA2	Ground-fault detection modules
3RK1901-1GA01	Overvoltage protection modules



6GK1210-0SA01	For cable extension, incl mounting plate
3RK1901-1MX02	AS-Interface extension plugs compact
3RK1901-1MX01	AS-Interface extension plugs plus
3RX9801-0AA00	AS-Interface M12 feeders, max 2A
3RK1901-1NR10	AS-Interface M12 feeders, 4A



3RK1904-2AB02	AS-Interface addressing unit V 3.0
----------------------	------------------------------------



Acuator Sensor Interface

Part Number	Description
AS-Interface: Slaves IP67	
K60 digital module Digital I/O modules, IP67 - K60	
3RK1200-0DQ00-0AA3	8 I, Standard, Y-II pin assign
3RK1400-1CQ00-0AA3	4I/4O, 2 A, Standard,
3RK2400-1DQ00-0AA3	4I/4O, 2 A, A/B
3RK2400-1FQ03-0AA3	4I/4O, 2 A, A/B
3RK2400-1FQ03-0AA3	4I/3O, 2 A, A/B, Y-II
3RK1400-1MQ00-0AA3	4I/2O, 2 A, Standard, Y-II
3RK1400-1DQ02-0AA3	2x2I/2x2 O, 1A, Standard
3RK1100-1CQ00-0AA3	4O, 2 A, Standard, Y-II
3RK2100-1CQ00-0AA3	4O, 2 A, A/B, Y-II
K60 mounting plates	
3RK1901-0CA00	Wall mounting
3RK1901-0CB01	Standard rail mounting
Digital I/O modules, IP67 - K45	
3RK2200-0DQ20-0AA3	8I, A/B, Y
3RK1200-0CQ20-0AA3	4I, Standard
3RK2200-0CQ20-0AA3	4I, A/B
3RK1400-1BQ20-0AA3	2I/2O, 2 A, Standard,
3RK1400-0GQ20-0AA3	2 x (1 I/1 O), 0.2 A, Standard
3RK2400-1GQ20-1AA3	4 x (1 I/1 O), 0.5 A, A/B
3RK2100-1CQ20-0AA3	4O, 1A, A/B
3RK1100-1CQ20-0AA3	4O, 1A, Standard
K45 mounting plates	
3RK1901-2EA00	Wall mounting
3RK1901-2DA00	Standard rail mounting
Analog I/O modules, IP67 – K60	
3RK1207-1BQ40-0AA3	2AI, current 4-20 mA or +- 20 mA
3RK1207-1BQ44-0AA3	4AI, current 4-20 mA or +- 20 mA
3RK1207-2BQ40-0AA3	2AI, voltage +/- 10V or 1-5 V
3RK1207-2BQ44-0AA3	4AI, voltage +/- 10V or 1-5 V
3RK1207-3BQ40-0AA3	2AI, Pt 100 orNi 100 or0 ... 600ohms
3RK1207-3BQ44-0AA3	4AI, Pt 100 orNi 100 or0 ... 600ohms
3RK1107-1BQ40-0AA3	2AO, current 4-20 mA or +- 20 mA
3RK1107-2BQ40-0AA3	2AO, voltage +/- 10V or 1-5 V
3RK2207-1BQ50-0AA3	2AI, current 4-20 mA or +- 20 mA, A/B
3RK2207-2BQ50-0AA3	2AI, voltage +/- 10V or 1-5 V, A/B



Acuator Sensor Interface Accessories

Part Number	Description
3RK1901-1KA00	AS-I M12 sealing caps, pack of 10
3RK1901-1KA01	AS-I M12 sealing caps, tamper-proof
3RK1901-1NN10	AS-I compact distributors, max 8A
3RK1901-1NR04	AS-I M12 feeders, 4-fold, max 4A
3RK1901-1NR11	M12 cable box
3RK1902-0AR00	Sealing sets, For mounting plate K60





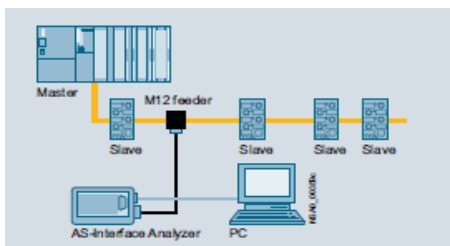
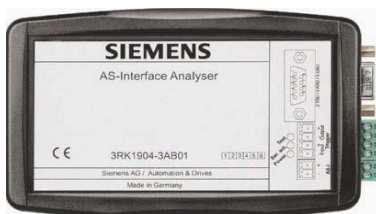

Analyzer

3RK1904-3AB01 AS-Interface analyzers
For troubleshooting and service assignments in installations and networks with AS-Interface systems



As-i Safety Technology

Part Number	Description	
ASIsafe Solution Local, Central units		
3RK3121-1AC00	3RK3 ASIsafe basic, 1/2 safe inputs	
3RK3122-1AC00	3RK3 ASIsafe extended, 2/4 safe inputs	
3RK3131-1AC10	3RK3 Advanced	
Expansion modules		
3RK3211-1AA10	4/8 F-DI	
3RK3221-1AA10	F-RO	
3RK3231-1AA10	2/4 F-DI 2F-DO	
3RK3251-1AA10	4/8 F-RO	
3RK3242-1AA10	4 F-DO	
3RK3321-1AA10	8 DI	
3RK3311-1AA10	8 DO	
Interface modules		
3RK3511-1BA10	DP interface	
3RK3611-3AA00	Operating and monitoring module	
AS-Interface safety monitors		
3RK1105-1AE04-0CA0	Basic safety monitors, One enabling cct	
3RK1105-1BE04-0CA0	Basic safety monitors, two enabling cct	
3RK1105-1AE04-2CA0	Expanded safety monitors One enabling ct	
3RK1105-1BE04-2CA0	Expanded safety monitors two enabling circuit	
3RK1105-1BE04-4CA0	Expanded safety monitors with integrated safe slave	
3RK1802-2FB06-0GA1	ASIMON V3 configuration software on CD ROM, for PC	
3RK1901-5AA00	Cable sets	

As-i Safety Technology

Part Number

Description

AS-Interface safety modules IP67

3RK1205-0BQ30-0AA3 2 F-DI, K45F

3RK1205-0BQ00-0AA3 2 F-DI, K45F

3RK1205-0CQ00-0AA3 4 F-DI, K45F

3RK1405-1BQ20-0AA3 2 F-DI/2 DO, K45F

S22.5F SlimLine safety modules

3RK1205-0BE00-0AA2 2 F-DI

3RK1405-1BE00-0AA2 2 F-DI/2 DO

S45F SlimLine safety modules

3RK1405-1SE15-0AA2 1F-RO/3DI/2DO

AS-Interface F adapters for EMERGENCY-STOP devices

3SF5402-1AB03 2I/O, with output for LED control



AS-i pushbutton stations

NOTE!!!

Customized pushbutton stations can be configure on:
Industry Mall: www.siemens.co.za/mall



NEW!!!!!! AS-i SlimLine Compact Module

Part Number

Description

AS-i SlimLine Compact modules



3RK2200-0CE00-2AA2 A/B slave, 4I, 2-wire 17.5mm

3RK2200-2CE00-2AA2 A/B slave, 4I, 3-wire 22.5mm

3RK2100-1CE00-2AA2 A/B slave, 4O, 2A solid-state 22.5mm

3RK2402-2ME00-2AA2 A/B slave, 4I/2O, 3-wire, Relay CO contacts, 22.5mm

3RK2402-2CE00-2AA2 A/B slave, 4I/4O, 3-wire, Relay CO contacts, 22.5mm

3RK2400-2CE00-2AA2 Standard slave, 4I/4O, 3-wire, 2A solid state 22.5mm

ASISafe SlimLine Compact modules



3RK1205-0BE00-2AA2 2 safe inputs, For mechanical contacts, 17.5mm

3RK1405-2BE00-2AA2 2 safe inputs/2 semiconductor outputs 17.5mm

Device connectors

3RK1901-1YA00 for 17.5 mm modules

3RK1901-1YA10 for 22.5 mm modules

3RK1901-1YA01 termination connector, 17.5mm

3RK1901-1YA11 termination connector, 22.5mm



SIRIUS Relays - 3RN & 3RP2

Part Number	Description	Contacts	Voltage
PTC Thermistor Relays			
3RN1000-1AM00	1 Sensor with Auto reset	1C/O	230V AC
3RN1010-1CB00	1 Sensor with Auto reset	1NO+1NC	24V UC
3RN1010-1CG00	1 Sensor with Auto reset	1NO+1NC	110V AC
3RN1010-1CM00	1 Sensor with Auto reset	1NO+1NC	230V AC
3RN1011-1CK00	1 Sensor with Man / remote reset	1NO+1NC	110/230VAC
3RN1012-1CK00	1 Sensor with Man / auto / remote reset	1NO+1NC	110/230VAC
3RN1062-1CW00	6 Sensors with Man / auto / remote reset	1NO+1NC	24-240V UC
Time Relays			
3RP2505-1AW30	Multifunctional timing relay, 13 functions, 15 time settings	1C/O	12 ... 240 AC/DC
3RP2505-1BT20	Multifunctional timing relay, 13 functions, 15 time settings	2C/O	400 ... 440 VAC
3RP2505-1BW30	Multifunctional timing relay, 13 functions, 15 time settings	2C/O	12 ... 240 AC/DC
3RP2511-1AW30	ON-Delay, 0.5 - 10s	1C/O	12 ... 240 AC/DC
3RP2512-1AW30	ON-Delay, 1.5 - 30s	1C/O	AC/DC
3RP2513-1AW30	ON-Delay, 5 - 100s	1C/O	AC/DC
3RP2525-1AW30	ON-Delay, 0.05 s ... 100 h	1C/O	AC/DC
3RP2525-1BW30	ON-Delay, 0.05 s ... 100 h	2C/O	AC/DC
3RP2527-1EW30	ON-Delay, Electronic delayed, 2 wire design, 4 time settings	1N/O	12 ... 240 AC/DC
3RP2540-1BB30	OFF-delay, without control signal, non-volatile, passing make contact	2C/O	12 ... 240 AC/DC
3RP2555-1AW30	clock-pulse relay, flashing, asymmetrica	1C/O	12 ... 240 AC/DC
3RP2560-1SW30	Star-delta function with overtravel function (idling), 1 - 20 s	1N/O	12 ... 240 AC/DC
3RP2574-1NW30	Star-delta function, 1 - 20 s	1N/O	12 ... 240 AC/DC
3RP2576-1NW30	Star-delta function, 3 - 60 s	1N/O	12 ... 240 AC/DC



SIRIUS Relays & Plug-In Relays With Base

Part Number	Description	Contacts	Voltage
-------------	-------------	----------	---------

Temperature Monitoring Relays

3RS1040-1GW50	One Sensor type - PT100/1000; KTY83/84; NTC	-50 ... +500 °C	24-240V AC/DC
3RS1041-1GW50	Three Sensors type - PT100/1000; KTY83/84; NTC	-50 ... +500 °C	24-240V AC/DC



Plug-in Relays - PT Range

LZX:PT270024	8 Pin Industrial Relay	2C/O	24V DC
LZX:PT370024	11 Pin Industrial Relay	3C/O	24V DC
LZX:PT570024	14 Pin Industrial Relay	4C/O	24V DC
LZX:PT270615	8 Pin Industrial Relay	2C/O	115V AC
LZX:PT370615	11 Pin Industrial Relay	3C/O	115V AC
LZX:PT570615	14 Pin Industrial Relay	4C/O	115V AC
LZX:PT270730	8 Pin Industrial Relay	2C/O	230V AC
LZX:PT370730	11 Pin Industrial Relay	3C/O	230V AC
LZX:PT570730	14 Pin Industrial Relay	4C/O	230V AC



Plug-in Relays - PT Range Base

LZS:PT78720	8 Pin Industrial Relay Base	For 2C/O	-
LZS:PT78730	11 Pin Industrial Relay Base	For 3C/O	-
LZS:PT78740	14 Pin Industrial Relay Base	For 4C/O	-
LZS:PT17024	Fixing/ejecting bracket	-	-
LZS:PTML0730	LED Module	-	110 - 230V AC
LZS:PTML0524	LED Module	-	24V AC/DC



Plug-in Relays - MT Range

LZX:MT323024	11 Pin Industrial Relay with LED	3C/O	24V DC
LZX:MT328115	11 Pin Industrial Relay with LED	3C/O	115V AC
LZX:MT328230	11 Pin Industrial Relay with LED	3C/O	230V AC



Plug-in Relays - MT Range Base

LZS:MT78750	Base for MT relay	-	-
LZS:MT28800	Fixing Bracket	-	-



Print Relays - RT Range

LZX:RT424024	8 pin print relay	2C/O	24V DC
LZX:RT424615	8 pin print relay	2C/O	115V AC
LZX:RT314730	8 pin print relay	1C/O	230V AC
LZS:RT78725	RT Relay Base	-	-



Technical Assistance :

<http://support.automation.siemens.com>

Share Call: 0860 80 80 80 (within RSA)

email: support.south-africa.automation@siemens.com

Simirel Relays

Part Number	Description	Contacts	Voltage
Coupling Relays			
3TX7002-1AB00	O/P interface coupling relay, 11.5mm	1N/O	24V AC/DC
3TX7002-1BB00	O/P interface coupling relay, 17.5mm	1C/O	24V AC/DC
3TX7002-1CB00	O/P interface coupling relay, 22.5mm	2N/O	24V AC/DC
3TX7002-2AB00	I/P interface coupling relay, 11.5mm	1N/O	24V AC/DC
3TX7002-2AE00	I/P interface coupling relay, 11.5mm	1N/O	110V AC
3TX7004-2MB02	I/P interface coupling relay, 6.2mm	1N/O	24V AC/DC
3TX7004-2ME02	I/P interface coupling relay, 6.2mm	1N/O	110V AC
3TX7004-2ME02	I/P interface coupling relay, 6.2mm	1N/O	220V AC



Plug-in Coupling Relays complete

3TX7015-1BB00	Interface coupling relay, 6.2mm	1C/O	24V AC/DC
3TX7015-1BE00	Interface coupling relay, 6.2mm	1C/O	115V AC/DC
3TX7015-1BF00	Interface coupling relay, 6.2mm	1C/O	230V AC/DC

Coupling Relays

3RS1800-1BW00	Coupling relay, industrial	2C/O	24-240V AC/DC
3RS1800-1BW00	Coupling relay, industrial	3C/O	24-240V AC/DC



Technical Assistance :

<http://support.automation.siemens.com>

Share Call: 0860 80 80 80 (within RSA)

email: support.south-africa.automation@siemens.com

SIRIUS Relays - Monitoring

Part Number	Description	Contacts	Voltage
-------------	-------------	----------	---------

Line Monitoring Relays - Phase monitoring relay

3UG4511-1AN20	Phase sequence monitoring relay - 3 phase	1C/O	160 - 260 VAC
3UG4511-1BN20	Phase sequence monitoring relay - 3 phase	2C/O	160 - 260 VAC
3UG4511-1AP20	Phase sequence monitoring relay - 3 phase	1C/O	360 - 520 VAC
3UG4511-1BP20	Phase sequence monitoring relay - 3 phase	2C/O	360 - 520 VAC
3UG4511-1AQ20	Phase sequence monitoring relay - 3 phase	1C/O	420 - 690 VAC
3UG4511-1BQ20	Phase sequence monitoring relay - 3 phase	2C/O	420 - 690 VAC



Line Monitoring Relays - Phase monitoring, failure and unbalance relay

3UG4512-1BR20	Phase failure and unbalance relay - 3 phase	2C/O	160 - 690 VAC
3UG4513-1BR20	Phase failure, unbalance & undervoltage relay - 3 phase	2C/O	160 - 690 VAC



Line Monitoring Relays - Digitally adjustable

3UG4615-1CR20	Phase failure, unbalance, undervoltage & overvoltage relay - 3 phase	2C/O	160 - 690 VAC
3UG4616-1CR20	Phase failure, unbalance, undervoltage & overvoltage relay - 3 phase + N	2C/O	160 - 690 VAC

Current Monitoring Relays - Digitally adjustable

3UG4622-1AW30	0.1 - 10A AC/DC, Overshoot & undershoot monitoring. ON & spike delay 0.1 - 20s, 1C/O contact.	24 - 240 VAC/DC
3UG4625-1CW30	DIGITAL MONITORING RELAY FOR FAULT CURRENT MONITORING (W. CURRENT TRANSFORMER 3UL23) SETTING RANGE 0.03A TO 40A STARTUP AND TRIPPING DELAY 0.1 TO 20S SWITCH-OFF HYSTERESIS UP TO 50% ALARM HYSTERESIS 5% FIXED WIDTH 22.5 MM, 2 CO CONTACTS W. OR W/O ERROR LOG SCREW TERMINAL	24 .. 240 VAC/DC



Add 3UL23:



SIRIUS Safety Relays

Part Number	Description	Voltage
Standard basic units		
3SK111-1AB30	RELAY ENABLING CIRCUITS 3 NO CONTACTS + RELAY SIGNALING CIRCUIT 1 NC	24VDC
3SK1111-1AW20	RELAY ENABLING CIRCUITS 3 NO CONTACTS + RELAY SIGNALING CIRCUIT 1 NC	110-240 DC/AC
3SK1112-1BB40	ELECTRONIC OUTPUTS 2 ENABLING CIRCUITS + 1 SIGNALING CIRCUIT	24VDC
Advanced basic units		
3SK1121-1AB40	RELAY ENABLING CIRCUITS 3 NO CONTACTS + RELAY SIGNALING CIRCUIT 1 NC	24VDC
3SK1121-1CB41	TIME DELAY 0.05-3S RELAY ENABLING CIRCUITS 2 INSTANTANEOUS NO CONTACTS 2 DELAYED NO CONTACTS	24VDC
Input expansions		
3SK1220-1AB40	FOR ONE ADDITIONAL 2-CHANNEL OR TWO 1-CHANNEL SENSORS	24VDC
3SK1230-1AW20	POWERSUPPLY FOR 3SK1 ADVANCED SERIES US = 115 - 230 V AC/DC	
Output expansions		
3SK1211-1BB00	4 RELAY ENABLING CIRCUITS 4 NO CONTACTS	24VDC
3SK1211-1BW20	4 RELAY ENABLING CIRCUITS 4 NO CONTACTS	110-240 DC/AC

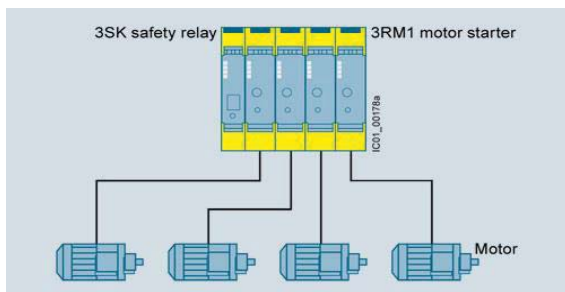

Conversion tool e.g. from 3TK28 to 3SK, see <http://www.siemens.com/sirius/conversion-tool>

SIRIUS 3SE5 - Mechanical Position Switches - Moulded Plastic

Part Number	Description	Contacts	
31mm Moulded Plastic enclosure, IP66/IP67 separate actuators			
3SE5232-0BC05	Slow action contacts, BODY ONLY without actuator	1NO+1NC	
3SE5232-0CC05	Snap action contacts, BODY ONLY without actuator	1NO+1NC	
40mm Moulded Plastic enclosure, IP66/IP67 separate actuators			
3SE5132-0BA00	Slow action contacts, BODY ONLY without actuator	1NO+1NC	
3SE5132-0CA00	Snap action contacts, BODY ONLY without actuator	1NO+1NC	
50mm Moulded Plastic enclosure, IP66/IP67 separate actuators			
3SE5242-0BC05	Slow action contacts, BODY ONLY without actuator	1NO+1NC	
3SE5242-0CC05	Snap action contacts, BODY ONLY without actuator	1NO+1NC	
3SE51 / 52 Separate actuators			
3SE5000-0AD03	Roller plungers, type C acc. to EN 50047 - Plastic rollers		
3SE5000-0AD04	Roller plungers, type C acc. to EN 50047 - High-grade steel rollers		
3SE5000-0AE10	levers, type	-	
3SE5000-0AE11	Roller levers, type E acc. to EN 50047 - Metal lever, high-grade steel roller		
3SE5000-0AF10	Angular roller levers - Metal lever, 13mm plastic roller		
3SE5000-0AF11	Angular roller levers - Metal lever, 13mm high-grade steel roller		
3SE5000-0AK00	Twist actuators, plastic (without lever) Switching right and/or left, adjustable		
3SE5000-0AA24	Twist levers 30 mm, straight - Metal lever, 19mm plastic roller		
3SE5000-0AA50	Twist levers, adjustable length - Metal lever, 19mm plastic roller		
3SE5000-0AA51	Twist levers, adjustable length - Metal lever, 19mm Metal lever, high-grade steel roller		
3SE5000-0AA62	Twist levers, adjustable length, with grid hole - High-grade steel lever, plastic roller		

Link to 3SE5 Limit switches overview

https://www.automation.siemens.com/mcms/infocenter/dokumentencenter/ce/Documentsu20B_rchures/e86060-t1812-a101-a8-7600.pdf

SIRIUS 3SE5 - Mechanical Position Switches - Metal

Part Number	Description	Contacts
56mm Metal enclosure, IP66/IP67		
3SE5122-0BE01	Slow Action w Roller levers With metal lever and plastic roller 22 mm	1NO+1NC
3SE5122-0CE01	Snap Action w Roller levers With metal lever and plastic roller 22 mm	1NO+1NC
3SE5122-0CH01	Snap Action Twist levers w metal lever 27 mm and plastic roller 19 mm	1NO+1NC
3SE5122-0CE01	Snap Action w Roller levers With metal lever and plastic roller 22 mm	1NO+1NC
3SE5122-0CB01	Snap Action w Plain plungers With high-grade steel plunger	1NO+1NC
3SE5122-0CC02	Snap Action Hounded plungers W high-grade steel plungers, 3 mm overtravel	1NO+1NC



More Options available, please contact your nearest Siemens office

3SE6 Magnetically operated switches



3SE6704-2BA	Rectangular sensor units - Switching magnets (coded) 25x88mm	
3SE6605-2BA	Contact blocks - With 3m cable, 25x88mm	1NO+1NC
3SE6604-2BA	Contact blocks - With 3m cable, 25x88mm	2 NC
3SE6605-2BA10	Contact blocks - With 10m cable, 25x88mm	1NO+1NC
3SE6604-2BA10	Contact blocks - With 10m cable, 25x88mm	2 NC
3SE6605-2BA01	Contact blocks - With M8 plug, 4-pole, 25x88mm	1NO+1NC
3SE6605-2BA01	Contact blocks - With M8 plug, 4-pole, 25x88mm	2 NC
3SE6806-2CD00	Monitoring units Safety relays with relay output, 6-sensors. Rated control supply voltage 24 V DC	2 NO / 1 NC



3SE6704-2BA



3SE6605-2BA



SIRIUS ACT - 3SU 22mm Plastic Range - Complete Units

Part Number 3SB3	Part Number 3SU	Description
3SB3202-0AA11	3SU1100-0AB10-1BA0	Flat Pushbutton, 1NO, Black
3SB3203-0AA21	3SU1100-0AB20-1CA0	Flat Pushbutton, 1NC, Red
3SB3202-0AA31	3SU1100-0AB30-1BA0	Flat Pushbutton, 1NO, Yellow
3SB3202-0AA41	3SU1100-0AB40-1BA0	Flat Pushbutton, 1NO, Green
3SB3202-2KA11	3SU1100-2BF60-1BA0	2-pos Selector switch, Black, maintained contact, 1NO
3SB3201-2KA11	3SU1100-2BF60-1MA0	2-pos Selector switch, Black, maintained contact, 1NO+1NC
3SB3210-2DA11	3SU1100-2BL60-1NA0	3-pos Selector switch, Black, maintained contact, 1NO+1NO
3SB3203-1CA21	3SU1100-1BA20-1CA0	40mm Mushroom E-stop, Red, push-pull, 1NC
3SB3203-1HR20	3SU1100-1HB20-1CG0	40mm Mushroom E-stop, Red, Twist-to-release 1NC
3SB3244-6BA20	3SU1102-6AA20-1AA0	Indicator light, 24V AC/DC, Red
3SB3244-6BA30	3SU1102-6AA30-1AA0	Indicator light, 24V AC/DC, Yellow
3SB3244-6BA40	3SU1102-6AA40-1AA0	Indicator light, 24V AC/DC, Green
3SB3244-6BA50	3SU1102-6AA50-1AA0	Indicator light, 24V AC/DC, Blue
3SB3244-6BA60	3SU1102-6AA60-1AA0	Indicator light, 24V AC/DC, Clear
3SB3248-6BA20	3SU1103-6AA20-1AA0	Indicator light, 110V AC, Red
3SB3248-6BA30	3SU1103-6AA30-1AA0	Indicator light, 110V AC, Yellow
3SB3248-6BA40	3SU1103-6AA40-1AA0	Indicator light, 110V AC, Green
3SB3248-6BA50	3SU1103-6AA50-1AA0	Indicator light, 110V AC, Blue
3SB3248-6BA60	3SU1103-6AA60-1AA0	Indicator light, 110V AC, Clear
	3SU1103-6AA00-1AA0	Indicator light, 110V AC, Amber
3SB3252-6BA20	3SU1106-6AA20-1AA0	Indicator light, 230V AC, Red
3SB3252-6BA30	3SU1106-6AA30-1AA0	Indicator light, 230V AC, Yellow
3SB3252-6BA40	3SU1106-6AA40-1AA0	Indicator light, 230V AC, Green
3SB3252-6BA50	3SU1106-6AA50-1AA0	Indicator light, 230V AC, Blue
	3SU1106-6AA00-1AA0	Indicator light, 230V AC, Amber
	3SU1106-6AA00-1AA0	Indicator light, 230V AC, Amber



More Options on below website

<http://www.siemens.com/sirius-act>

SIRIUS ACT - 3SU 22mm Plastic Range, Individual Components

Part Number	Description	
Old 3SB3	New 3SU	
3SB3000-0AA11	3SU1000-0AB10-0AA0	Flat Pushbutton, Black
3SB3000-0AA21	3SU1000-0AB20-0AA0	Flat Pushbutton, Red
3SB3000-0AA31	3SU1000-0AB30-0AA0	Flat Pushbutton, Yellow
3SB3000-0AA41	3SU1000-0AB40-0AA0	Flat Pushbutton, Green
3SB3000-0AA51	3SU1000-0AB50-0AA0	Flat Pushbutton, Blue
3SB3000-0AA71	3SU1000-0AB70-0AA0	Flat Pushbutton, Clear
3SB3000-2KA11	3SU1002-2BF60-0AA0	2-pos Selector switch, Black with white strip
3SB3000-2DA11	3SU1002-2BL60-0AA0	3-pos, Selector switch, maintained, Black with white strip
3SB3000-2EA11	3SU1002-2BM60-0AA0	3-pos, Selector switch, momentary, Black with white strip
3SB3000-1HA20	3SU1001-1HB20-0AA0	40mm Mushroom E-stop, Red, Twist-to-release, can be illuminated
3SB3000-1KA20	3SU1000-1HR20-0AA0	40mm Mushroom E-stop, Red, Twist-to-release (CES Lock)
3SB3001-6BA20	3SU1001-6AA20-0AA0	Indicator light, Red
3SB3001-6BA30	3SU1001-6AA30-0AA0	Indicator light, Yellow
3SB3001-6BA40	3SU1001-6AA40-0AA0	Indicator light, Green
3SB3001-6BA50	3SU1001-6AA50-0AA0	Indicator light, Blue
3SB3001-6BA60	3SU1001-6AA60-0AA0	Indicator light, White
3SB3001-6AA20	3SU1001-6AA20-0AA0	Indicator light, Red
3SB3001-6AA30	3SU1001-6AA30-0AA0	Indicator light, Yellow
3SB3001-6AA40	3SU1001-6AA40-0AA0	Indicator light, Green
3SB3001-6AA50	3SU1001-6AA50-0AA0	Indicator light, Blue
3SB3001-6AA60	3SU1001-6AA60-0AA0	Indicator light, White
3SB3001-6AA70	3SU1001-6AA60-0AA0	Indicator light, Clear
	3SU1001-6AA00-0AA0	Indicator light, Amber
All separate Actuators need a holder (3SU1500-0AA10-0AA0)		
3SU1500-0AA10-0AA0	Holders without module, Plastic for 3 Modules	
3SU1400-1AA10-1BA0	Aux Contacts for 3SU, 1NO	
3SU1400-1AA10-1CA0	Aux Contacts for 3SU, 1NC	
3SU1400-1AA10-1FA0	Aux Contacts for 3SU, 1NO+1NC	
3SU1401-1BB00-1AA0	LED modules for 3SU, 24V DC, Amber	
3SU1401-1BB20-1AA0	LED modules for 3SU, 24V DC, Red	
3SU1401-1BB30-1AA0	LED modules for 3SU, 24V DC, Yellow	
3SU1401-1BB40-1AA0	LED modules for 3SU, 24V DC, Green	
3SU1401-1BB50-1AA0	LED modules for 3SU, 24V DC, Blue	
3SU1401-1BB60-1AA0	LED modules for 3SU, 24V DC, White	
3SU1401-1BC00-1AA0	LED modules for 3SU, 110V AC, Amber	
3SU1401-1BC20-1AA0	LED modules for 3SU, 110V AC, Red	
3SU1401-1BC30-1AA0	LED modules for 3SU, 110V AC, Yellow	
3SU1401-1BC40-1AA0	LED modules for 3SU, 110V AC, Green	
3SU1401-1BC50-1AA0	LED modules for 3SU, 110V AC, Blue	
3SU1401-1BC60-1AA0	LED modules for 3SU, 110V AC, White	
3SU1401-1BF00-1AA0	LED modules for 3SU, 230V AC, Amber	
3SU1401-1BF20-1AA0	LED modules for 3SU, 230V AC, Red	
3SU1401-1BF30-1AA0	LED modules for 3SU, 230V AC, Yellow	
3SU1401-1BF40-1AA0	LED modules for 3SU, 230V AC, Green	
3SU1401-1BF50-1AA0	LED modules for 3SU, 230V AC, Blue	
3SU1401-1BF60-1AA0	LED modules for 3SU, 230V AC, White	

SIRIUS ACT - 3SU 22 Plastic Range





Part Number		Description
Old 3SB3	New 3SU	
3SB3001-0AA21	3SU1001-0AB20-0AA0	Illuminated Flat Pushbutton
3SB3001-0AA31	3SU1001-0AB30-0AA0	Illuminated Flat Pushbutton
3SB3001-0AA41	3SU1001-0AB40-0AA0	Illuminated Flat Pushbutton
3SB3001-0AA51	3SU1001-0AB50-0AA0	Illuminated Flat Pushbutton
3SB3001-0AA61	3SU1001-0AB60-0AA0	Illuminated Flat Pushbutton
3SB3000-0AA71	3SU1000-0AB70-0AA0	Illuminated Flat Pushbutton
3SB3000-4AD11	3SU1000-4BF11-0AA0	Ronix Key Switch, 2-pos, key removal O+, Maintained
3SB3000-4MD01	3SU1000-5BC01-0AA0	CES Key Switch, 2-pos, SSG10 key removal O, Momentary
3SB3100-8AC21	3SU1000-3AB42-0AK0	Flat Twin pushbuttons, Green / Red
3SB3101-8BC21	3SU1001-3AB42-0AK0	Illuminated Twin pushbuttons, Green / Red
All separate Actuators need a holder (3SU1500-0AA10-0AA0)		
3SU1500-0AA10-0AA0	Holders without module, Plastic for 3 Modules	
3SU1400-1AA10-1BA0	Aux Contacts for 3SU, 1NO	
3SU1400-1AA10-1CA0	Aux Contacts for 3SU, 1NC	
3SU1400-1AA10-1FA0	Aux Contacts for 3SU, 1NO+1NC	
3SU1401-1BB00-1AA0	LED modules for 3SU, 24V DC, Amber	
3SU1401-1BB20-1AA0	LED modules for 3SU, 24V DC, Red	
3SU1401-1BB30-1AA0	LED modules for 3SU, 24V DC, Yellow	
3SU1401-1BB40-1AA0	LED modules for 3SU, 24V DC, Green	
3SU1401-1BB50-1AA0	LED modules for 3SU, 24V DC, Blue	
3SU1401-1BB60-1AA0	LED modules for 3SU, 24V DC, White	
3SU1401-1BC00-1AA0	LED modules for 3SU, 110V AC, Amber	
3SU1401-1BC20-1AA0	LED modules for 3SU, 110V AC, Red	
3SU1401-1BC30-1AA0	LED modules for 3SU, 110V AC, Yellow	
3SU1401-1BC40-1AA0	LED modules for 3SU, 110V AC, Green	
3SU1401-1BC50-1AA0	LED modules for 3SU, 110V AC, Blue	
3SU1401-1BC60-1AA0	LED modules for 3SU, 110V AC, White	
3SU1401-1BF00-1AA0	LED modules for 3SU, 230V AC, Amber	
3SU1401-1BF20-1AA0	LED modules for 3SU, 230V AC, Red	
3SU1401-1BF30-1AA0	LED modules for 3SU, 230V AC, Yellow	
3SU1401-1BF40-1AA0	LED modules for 3SU, 230V AC, Green	
3SU1401-1BF50-1AA0	LED modules for 3SU, 230V AC, Blue	
3SU1401-1BF60-1AA0	LED modules for 3SU, 230V AC, White	



More Options on below website

<http://www.siemens.com/sirius-act>

SIRIUS ACT - 3SU 22 Metal Range

Part Number		Description	
Old 3SB3	New 3SU		
3SB3602-0AA11	3SU1150-0AB10-1BA0	Flat Pushbutton, 1NO, Black	
3SB3603-0AA21	3SU1150-0AB20-1CA0	Flat Pushbutton, 1NC, Red	
3SB3602-0AA31	3SU1150-0AB30-1BA0	Flat Pushbutton, 1NO, Yellow	
3SB3602-0AA41	3SU1150-0AB40-1BA0	Flat Pushbutton, 1NO, Green	
3SB3602-2KA11	3SU1150-2BF60-1BA0	2-pos Selector switch, Black, maintained contact, 1NO	
3SB3601-2KA11	3SU1150-2BF60-1MA0	2-pos Selector switch, Black, maintained contact, 1NO+1NC	
3SB3610-2DA11	3SU1150-2BL60-1NA0	3-pos Selector switch, Black, maintained contact, 1NO+1NO	
3SB3603-1HA20	3SU1150-1HB20-1CG0	40mm Mushroom E-stop, Twist-to-release, 1N/C	
3SB3644-6BA20	3SU1152-6AA20-1AA0	Indicator light, 24V AC/DC, Red	
3SB3644-6BA30	3SU1152-6AA30-1AA0	Indicator light, 24V AC/DC, Yellow	
3SB3644-6BA40	3SU1152-6AA40-1AA0	Indicator light, 24V AC/DC, Green	
3SB3648-6BA20	3SU1153-6AA20-1AA0	Indicator light, 110V AC, Red	
3SB3648-6BA30	3SU1153-6AA30-1AA0	Indicator light, 110V AC, Yellow	
3SB3648-6BA40	3SU1153-6AA40-1AA0	Indicator light, 110V AC, Green	
3SB3648-6BA60	3SU1153-6AA60-1AA0	Indicator light, 110V AC, White	
3SB3652-6BA20	3SU1156-6AA20-1AA0	Indicator light, 230V AC, Red	
3SB3652-6BA30	3SU1156-6AA30-1AA0	Indicator light, 230V AC, Yellow	
3SB3652-6BA40	3SU1156-6AA40-1AA0	Indicator light, 230V AC, Green	
3SB3652-6BA50	3SU1156-6AA50-1AA0	Indicator light, 230V AC, Blue	
Individual Components - Separate Holder needed			
3SB3500-0AA11	3SU1050-0AB10-0AA0	Flat Pushbutton, Black	
3SB3500-0AA21	3SU1050-0AB20-0AA0	Flat Pushbutton, Red	
3SB3500-0AA31	3SU1050-0AB30-0AA0	Flat Pushbutton, Yellow	
3SB3500-0AA41	3SU1050-0AB40-0AA0	Flat Pushbutton, Green	
3SB3500-0AA51	3SU1050-0AB50-0AA0	Flat Pushbutton, Blue	
3SB3500-0AA71	3SU1050-0AB70-0AA0	Flat Pushbutton, Clear	
3SB3500-2KA11	3SU1052-2BF60-0AA0	2-pos Selector switch, Black, maintained contact, 1NO	
3SB3500-2KA11	3SU1052-2BF60-0AA0	2-pos Selector switch, Black, maintained contact, 1NO+1NC	
3SB3500-2DA11	3SU1052-2BL60-0AA0	3-pos Selector switch, Black, maintained contact, 1NO+1NO	
3SB3500-1HA20	3SU1051-1HB20-0AA0	40mm Mushroom E-stop, Red, Twist-to-release, can be illuminated	
All separate Actuators need a holder (3SU1550-0AA10-0AA0)			
3SU1550-0AA10-0AA0	Holders without module, Metal for 3 Modules		
3SU1400-1AA10-1BA0	Aux Contacts for 3SU, 1NO		
3SU1400-1AA10-1CA0	Aux Contacts for 3SU, 1NC		
3SU1400-1AA10-1FA0	Aux Contacts for 3SU, 1NO+1NC		

More Options on below website

<http://www.siemens.com/sirius-act>

SIRIUS ACT - 3SU 22 Metal Range

Part Number	Description	Contacts
Individual Components		
Old 3SB3		
3SB3501-6BA20	Indicator light, Red	
3SB3501-6BA30	Indicator light, Yellow	
3SB3501-6BA40	Indicator light, Green	
3SB3501-6BA50	Indicator light, Blue	
New 3SU		
3SB3501-6AA20	Indicator light, Red	
3SB3501-6AA30	Indicator light, Yellow	
3SB3501-6AA40	Indicator light, Green	
3SB3501-0AA21	Illuminated Flat Pushbutton, Red	
3SB3501-0AA31	Illuminated Flat Pushbutton, Yellow	
3SB3501-0AA41	Illuminated Flat Pushbutton, Green	
3SB3501-0AA51	Illuminated Flat Pushbutton, Blue	
All separate Actuators need a holder (3SU1550-0AA10-0AA0)		
3SU1550-0AA10-0AA0	Holders without module, Metal for 3 Modules	
3SU1400-1AA10-1BA0	Aux Contacts for 3SU, 1NO	
3SU1400-1AA10-1CA0	Aux Contacts for 3SU, 1NC	
3SU1400-1AA10-1FA0	Aux Contacts for 3SU, 1NO+1NC	
3SU1401-1BB00-1AA0	LED modules for 3SU, 24V DC, Amber	
3SU1401-1BB20-1AA0	LED modules for 3SU, 24V DC, Red	
3SU1401-1BB30-1AA0	LED modules for 3SU, 24V DC, Yellow	
3SU1401-1BB40-1AA0	LED modules for 3SU, 24V DC, Green	
3SU1401-1BB50-1AA0	LED modules for 3SU, 24V DC, Blue	
3SU1401-1BB60-1AA0	LED modules for 3SU, 24V DC, White	
3SU1401-1BC00-1AA0	LED modules for 3SU, 110V AC, Amber	
3SU1401-1BC20-1AA0	LED modules for 3SU, 110V AC, Red	
3SU1401-1BC30-1AA0	LED modules for 3SU, 110V AC, Yellow	
3SU1401-1BC40-1AA0	LED modules for 3SU, 110V AC, Green	
3SU1401-1BC50-1AA0	LED modules for 3SU, 110V AC, Blue	
3SU1401-1BC60-1AA0	LED modules for 3SU, 110V AC, White	
3SU1401-1BF00-1AA0	LED modules for 3SU, 230V AC, Amber	
3SU1401-1BF20-1AA0	LED modules for 3SU, 230V AC, Red	
3SU1401-1BF30-1AA0	LED modules for 3SU, 230V AC, Yellow	
3SU1401-1BF40-1AA0	LED modules for 3SU, 230V AC, Green	
3SU1401-1BF50-1AA0	LED modules for 3SU, 230V AC, Blue	
3SU1401-1BF60-1AA0	LED modules for 3SU, 230V AC, White	
3SB3922-0AV	3SU1900-0AG10-0AA0	Label holders for labeling plates 12.5x27mm
3SB3923-0AV	3SU1900-0AT10-0AA0	Label holders for labeling plates 27x27mm
3SB3925-0AV	3SU1900-0AS10-0AA0	Label holders for labeling plates 17.5x27mm
3SB3902-1AA	3SU1900-0AC16-0AA0	Blank Labeling plate 12.5mm x 27mm
3SB1906-2AA	3SU1900-0AE81-0AA0	Blank Labeling plate 27mm x 27mm
3SU1900-0AD81-0AA0		Blank Labeling plate 17.5mm x 27mm



More Options on below website

<http://www.siemens.com/sirius-act>

SIRIUS ACT - 3SU 22mm Enclosures

Part Number

Description

Plastic Enclosures for surface mounting

3SB3801-0AD3	3SU1801-0AA00-0AC2	Empty enclosure with protective collar
3SB3801-0DG3	3SU1801-0NA00-2AA2	E-stop enclosure without protective collar, 1NC
3SB3801-0DF3	3SU1801-0NA00-2AC2	E-stop enclosure with protective collar, 1NC
3SB3801-0EF3	3SU1801-0NB00-2AC2	E-stop enclosure with protective collar, 2NC
3SB3801-0AA3	3SU1801-0AA00-0AB1	1-Pos Empty enclosure - Plastic
3SB3802-0AA3	3SU1802-0AA00-0AB1	2-Pos Empty enclosure - Plastic
3SB3803-0AA3	3SU1803-0AA00-0AB1	3-Pos Empty enclosure - Plastic
3SB3804-0AA3	3SU1804-0AA00-0AB1	4-Pos Empty enclosure - Plastic
3SB3806-0AA3	3SU1806-0AA00-0AB1	6-Pos Empty enclosure - Plastic



Metal Enclosures for surface mounting

3SB3801-2AD3	3SU1851-0AA00-0AC2	Empty enclosure with protective collar
3SB3801-2DG3	3SU1851-0NA00-2AA2	E-stop enclosure without protective collar, 1NC
3SB3801-2DF3	3SU1851-0NA00-2AC2	E-stop enclosure with protective collar, 1NC
3SB3801-2EF3	3SU1851-0NB00-2AC2	E-stop enclosure with protective collar, 2NC
3SB3801-2AA3	3SU1851-0AA00-0AB1	1-Pos Empty enclosure - Plastic
3SB3802-2AA3	3SU1852-0AA00-0AB1	2-Pos Empty enclosure - Plastic
3SB3803-2AA3	3SU1853-0AA00-0AB1	3-Pos Empty enclosure - Plastic
3SB3804-2AA3	3SU1854-0AA00-0AB1	4-Pos Empty enclosure - Plastic
3SB3806-2AA3	3SU1856-0AA00-0AB1	6-Pos Empty enclosure - Plastic



3SB3420-0B	3SU1400-2AA10-1BA0	Base mounted 1N/O aux. block
3SB3420-0C	3SU1400-2AA10-1CA0	Base mounted 1N/C aux. block



3SB3420-1PB	3SU1401-2BB20-1AA0	Lamp Holder with integrated LED, 24V UC
-------------	--------------------	---

3SB3420-1PC	3SU1401-2BB40-1AA0	Lamp Holder with integrated LED, 24V UC
-------------	--------------------	---

3SB3420-1PE	3SU1401-2BB60-1AA0	Lamp Holder with integrated LED, 24V UC
-------------	--------------------	---

3SB3420-1RB	3SU14012BF201AA0	Lamp Holder with integrated LED, 230V AC
-------------	------------------	--

3SB3420-1RC	3SU1401-2BF40-1AA0	Lamp Holder with integrated LED, 230V AC
-------------	--------------------	--

3SB3420-1RE	3SU14012BF601AA0	Lamp Holder with integrated LED, 230V AC
-------------	------------------	--



www.siemens.com/sirius-act/configurator

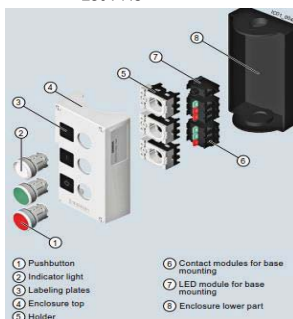

INDUSTRIAL CONTROLS

3RM1 Motor Starters For Use In Control Cabinets

Part Number	kW @ 400V	In (A)	Control Voltage
3RM10 direct-on-line Starters - Screw Connection			
3RM1001-1AA04	0 - 0.12	0.1 - 0.5	24V DC
3RM1002-1AA04	0.09 - 0.75	0.4 - 2	24V DC
3RM1007-1AA04	0.55 - 3	1.6 - 7	24V DC
3RM1001-1AA14	0 - 0.12	0.1 - 0.5	110-230V AC
3RM1002-1AA14	0.09 - 0.75	0.4 - 2	110-230V AC
3RM1007-1AA14	0.55 - 3	1.6 - 7	110-230V AC

3RM12 Reversing Starters - Screw Connection			
3RM1201-1AA04	0 - 0.12	0.1 - 0.5	24V DC
3RM1202-1AA04	0.09 - 0.75	0.4 - 2	24V DC
3RM1207-1AA04	0.55 - 3	1.6 - 7	24V DC
3RM1201-1AA14	0 - 0.12	0.1 - 0.5	110-230V AC
3RM1202-1AA14	0.09 - 0.75	0.4 - 2	110-230V AC
3RM1207-1AA14	0.55 - 3	1.6 - 7	110-230V AC

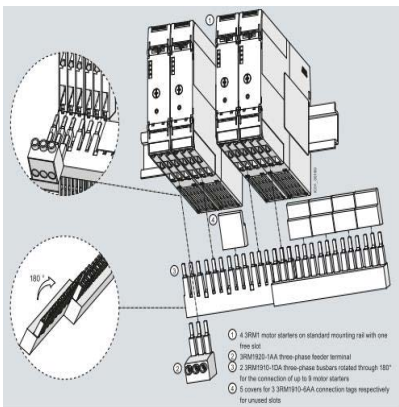

3RM1910 rail system with three-phase feeder terminal. In the above example, two three-phase busbars (3-pole busbars) rotated through 180° allow up to 8 3RM1 motor starters to be connected. Contact with the unused connection tags in unoccupied positions is prevented solely by the covers.

3RM1 Accessories

3RM1920-1AA	3-phase feeder terminal
3RM1910-1AA	3-phase busbar for 2 3RM1 Starters
3RM1910-1BA	3-phase busbar for 3 3RM1 Starters
3RM1910-1DA	3-phase busbar for 5 3RM1 Starters
3RM1910-6AA	Cover for connection tags not used.



Accessories For Sirius Innovations 3RA23 Reversing Contractors Assemblies

Part Number

Description

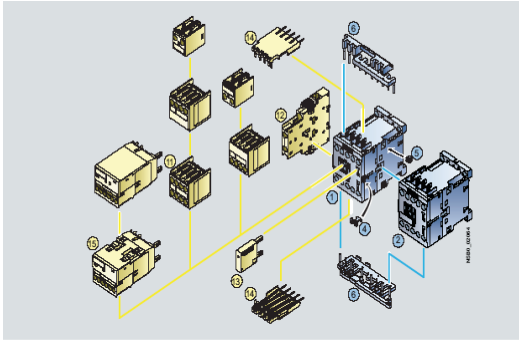

Mountable accessories

Accessories	Order No.	Page
11 Auxiliary switch block, front (auxiliary switch block according to EN 50066 must be used)	3RH29 11-1....	3/84
12 Auxiliary switch block, lateral	3RH29 21-1DA...	3/85
13 Surge suppressor	3RT29 16-1....	3/89
14 Solder pin adapter	3RT 19 16-4KA1	3/92
15 Function module for connection to the control system	3RT27 1-1BA00	3/93

Fully wired and tested contractor assemblies

Individual parts	Order No.	Q11	Q12
1 2 Contactors, 3 kW	3RT20 15	3RT20 15	
1 2 Contactors, 4 kW	3RT20 16	3RT20 16	
1 2 Contactors, 5.5 kW	3RT20 17	3RT20 17	
1 2 Contactors, 7.5 kW	3RT20 18	3RT20 18	
4 5 6 Assembly kit comprising:	3RA29 13-2AA1		
4 Mechanical interlocks			
5 2 connecting clips for 2 contactors			
6 Wiring modules on the top and bottom for connecting the main current paths, electrical interlock included ¹⁾ , interruptible (NC contact interlock)			

¹⁾ 3RT20 1, contactors with one NC contact in the basic unit are required for the electrical interlock.

3RA2913-2AA1

Assembly kit for S00 3RT201 contactors complete with mechanical interlock and connecting links top and bottom

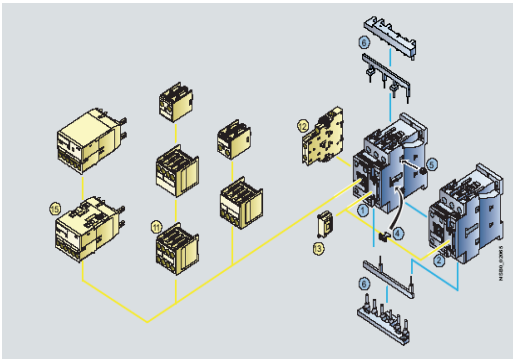

Mountable accessories

Individual parts	Order No.	Page
11 Auxiliary switch block, front	3RH29 21-1....	3/84
12 Auxiliary switch block, lateral	3RH29 21-1DA...	3/85
13 Surge suppressor	3RT29 26-1....	3/89
15 Function module for connection to the control system	3RT27 1-1BA00	3/93

Fully wired and tested contractor assemblies

Individual parts	Order No.	Q11	Q12
1 2 Contactors, 5.5 kW	3RT20 24	3RT20 24	
1 2 Contactors, 7.5 kW	3RT20 25	3RT20 25	
1 2 Contactors, 11 kW	3RT20 26	3RT20 26	
1 2 Contactors, 15 kW	3RT20 27	3RT20 27	
1 2 Contactors, 18.5 kW	3RT20 28	3RT20 28	
4 5 6 Assembly kit comprising:	3RA29 23-2AA1		
4 Mechanical interlocks			
5 2 connecting clips for 2 contactors			
6 Wiring modules on the top and bottom for connecting the main current paths, electrical interlock included (NC contact interlock)			

3RA2923-2AA1

Assembly kit for S0 3RT202 contactors complete with mechanical interlock and connecting links top and bottom

Accessories For Sirius Innovations 3RA23 Star / Delta Contractors Assemblies

Part Number

Description

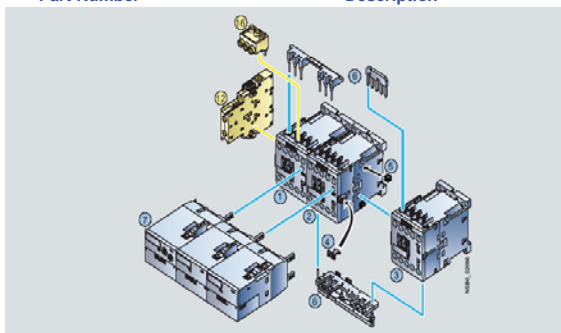

Mountable accessories

Individual parts	Order No.	Page
12 Auxiliary switch block, lateral	3RH29 21-1DA..	3/85
16 3-phase feeder terminal ¹⁾	3RA29 13-3K	3/42

Fully wired and tested contactor assemblies

Individual parts	Order No.	Q11 ¹⁾	Q13 ²⁾	Q12 ²⁾
1-2-3 Contactors, 5.5 kW	3RT20 15	3RT20 15	3RT20 15	3RT20 15
1-2-3 Contactors, 7.5 kW	3RT20 17	3RT20 17	3RT20 17	3RT20 15
1-2-3 Contactors, 11 kW	3RT20 18	3RT20 18	3RT20 18	3RT20 16
4-5-6 Assembly kit comprising: 4 Mechanical interlock 5 4 connecting clips 6 Wiring modules on the top and bottom for connecting the main current paths	3RA29 13-2BB1			
7 Function modules for wye-delta starting	3RA28 16-0EW20			

3RA2913-2BB1

Assembly key for S00 3RT201 contactors complete with mechanical interlock and connecting links top and bottom

3RA2816-0EW20

Function Module for Star/Delta

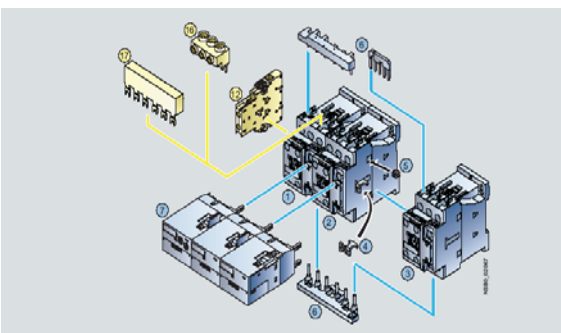

Mountable accessories

Individual parts	Order No.	Page
12 Auxiliary switch block, lateral	3RH29 21-1DA..	3/85
16 Three-phase feeder terminal ¹⁾	3RV29 25-5AB	3/41
17 Three-phase busbar ¹⁾	3RV19 15-1AB	3/41

Fully wired and tested contactor assemblies

Individual parts	Order No.	Q11	Q13	Q12
1-2-3 Contactors, 11 kW	3RT20 24	3RT20 24	3RT20 24	3RT20 24
1-2-3 Contactors, 15/16.5 kW	3RT20 26	3RT20 26	3RT20 26	3RT20 24
1-2-3 Contactors, 22 kW	3RT20 27	3RT20 27	3RT20 27	3RT20 26
4-5-6 Assembly kit The assembly kit contains: 4 Mechanical interlock 5 Connecting clips 6 Wiring modules on the top and bottom for connecting the main current paths	3RA29 23-2BB1			
7 Function modules for wye-delta starting	3RA28 16-0EW20			

3RA2923-2BB1

Assembly key for S0 3RT202 contactors complete with mechanical interlock and connecting links top and bottom

Accessories For Sirius Innovations 3RA23 Reversing Contractors & 3RA24 Star/ Delta Assemblies

Part Number

Description

3RA23 Function modules for connection to the control system

3RA2711-1BA00 **IO-Link connection**, comprising one basic and one coupling module and an additional module connector for assembling an IO-Link group

3RA2712-1BA00 **AS-I connection**, comprising one basic and one coupling module



3RA2711-0EE02 14-pole Module connector, 8cm, for function modules 3RA27 - S00 & S0

3RA2711-0EE03 14-pole Module connector, 21cm, for function modules 3RA27 - S00 & S0

3RA2711-0EE04 10-pole Module connector, 8cm, for function modules 3RA27, for aux. voltage suppl with IO-link - S00 & S0



3RA24 Function modules for connection to the control system

3RA2711-1CA00 **IO-Link connection**, comprising one basic and two coupling module and an additional module connector for assembling an IO-Link group

3RA2712-1CA00 **AS-I connection**, comprising one basic and one coupling module



3RA2711-0EE02 14-pole Module connector, 8cm, for function modules 3RA27 - S00 & S0

3RA2711-0EE03 14-pole Module connector, 21cm, for function modules 3RA27 - S00 & S0

3RA2711-0EE04 10-pole Module connector, 8cm, for function modules 3RA27, for aux. voltage suppl with IO-link - S00 & S0



Operator panel for communication through IO-Link

3RA6935-0A Operator panel with 3RA6936-0A enabling module, blanking cover and fixing terminal for S00 & S0

3RA2711-0EE11 Connection cables, length 2 m, 10- to 14-pole, for connection from the BB to the communication module, for size S00/S0



Technical Assistance :

<http://support.automation.siemens.com>

Share Call: 0860 80 80 80 (within RSA)

email: support.south-africa.automation@siemens.com

3RA6 - Compact Starters

Part Number	Description	Overload range	Control Voltage
3RA61 Direct-on-line starters			
3RA6120-1AP32	Combinaton CB, contactor and electronic overload	0.1 - 0.4A	110 - 240V AC/DC
3RA6120-1BP32	Combinaton CB, contactor and electronic overload	0.32 - 1.25A	110 - 240V AC/DC
3RA6120-1CP32	Combinaton CB, contactor and electronic overload	1 - 4A	110 - 240V AC/DC
3RA6120-1DP32	Combinaton CB, contactor and electronic overload	3 - 12A	110 - 240V AC/DC
3RA6120-1EP32	Combinaton CB, contactor and electronic overload	8 - 32A	110 - 240V AC/DC
3RA6120-1AB32	Combinaton CB, contactor and electronic overload	0.1 - 0.4A	24V AC/DC
3RA6120-1BB32	Combinaton CB, contactor and electronic overload	0.32 - 1.25A	24V AC/DC
3RA6120-1CB32	Combinaton CB, contactor and electronic overload	1 - 4A	24V AC/DC
3RA6120-1DB32	Combinaton CB, contactor and electronic overload	3 - 12A	24V AC/DC
3RA6120-1EB32	Combinaton CB, contactor and electronic overload	8 - 32A	24V AC/DC
3RA6970-3B	AS-I module with safe disconnection		
3RA6950-0A	Control kit for mechanical actuation		
3RA6911-1A	Auxilliary switch block		2NO
3RA6912-1A	Auxilliary switch block		2NC
3RA6913-1A	Auxilliary switch block		1NO + 1NC



3RA6 - Compact Starters

Part Number	Description	Overload range	Control Voltage
3RA62 Reversing starters			
3RA6250-1AP32	Combinaton CB, contactor and electronic overload	0.1 - 0.4A	110 - 240V AC/DC
3RA6250-1BP32	Combinaton CB, contactor and electronic overload	0.32 - 1.25A	110 - 240V AC/DC
3RA6250-1CP32	Combinaton CB, contactor and electronic overload	1 - 4A	110 - 240V AC/DC
3RA6250-1DP32	Combinaton CB, contactor and electronic overload	3 - 12A	110 - 240V AC/DC
3RA6250-1EP32	Combinaton CB, contactor and electronic overload	8 - 32A	110 - 240V AC/DC
3RA6250-1AB32	Combinaton CB, contactor and electronic overload	0.1 - 0.4A	24V AC/DC
3RA6250-1BB32	Combinaton CB, contactor and electronic overload	0.32 - 1.25A	24V AC/DC
3RA6250-1CB32	Combinaton CB, contactor and electronic overload	1 - 4A	24V AC/DC
3RA6250-1DB32	Combinaton CB, contactor and electronic overload	3 - 12A	24V AC/DC
3RA6250-1EB32	Combinaton CB, contactor and electronic overload	8 - 32A	24V AC/DC
3RA6970-3A	Basic AS-I module		
3RA6970-3B	AS-I module with 2 local inputs		
3RA6970-3C	AS-I module with 2 free external inputs		
3RA6970-3D	AS-I module with 1 free external input and 1 free external output		
3RA6970-3E	AS-I module with 2 free external outputs		
3RK1904-2AB01	AS-I addressing unit		
3RA6950-0A	Control kit for mechanical actuation		
3RA6911-1A	Auxilliary switch block		2NO
3RA6912-1A	Auxilliary switch block		2NC
3RA6913-1A	Auxilliary switch block		1NO + 1NC



3RA64, 3RA65 - Compact Starters With IO-Link

Part Number	Description	Overload range	Control Voltage
-------------	-------------	----------------	-----------------

3RA61 Direct-on-line starters for IO-Link

3RA6400-1AB42	Combinaton CB, contactor and electronic overload	0.1 - 0.4A	24V AC/DC
3RA6400-1BB42	Combinaton CB, contactor and electronic overload	0.32 - 1.25A	24V AC/DC
3RA6400-1CB42	Combinaton CB, contactor and electronic overload	1 - 4A	24V AC/DC
3RA6400-1DB42	Combinaton CB, contactor and electronic overload	3 - 12A	24V AC/DC
3RA6400-1EB42	Combinaton CB, contactor and electronic overload	8 - 32A	24V AC/DC



3RA64. with 3RA6911 auxiliary switch block

3RA61 Reversing starters for IO-Link

3RA6500-1AB42	Combinaton CB, contactor and electronic overload	0.1 - 0.4A	24V AC/DC
3RA6500-1BB42	Combinaton CB, contactor and electronic overload	0.32 - 1.25A	24V AC/DC
3RA6500-1CB42	Combinaton CB, contactor and electronic overload	1 - 4A	24V AC/DC
3RA6500-1DB42	Combinaton CB, contactor and electronic overload	3 - 12A	24V AC/DC
3RA6500-1EB42	Combinaton CB, contactor and electronic overload	8 - 32A	24V AC/DC



3RA65. with 3RA6911 auxiliary switch block

Accessories for 3RA64 & 3RA65 Compact Starters

3RA6950-0A	Control kit for mechanical actuation		
3RA6911-1A	Auxilliary switch block	2NO	
3RA6912-1A	Auxilliary switch block	2NC	
3RA6913-1A	Auxilliary switch block	1NO + 1NC	
3RA6920-1A	Main circuit terminals	2NO	



3RA64, 3RA65 - Compact Starters With IO-Link

Part Number

Description

Accessories for 3RA64 & 3RA65 Compact Starters IO-Link

3RA6931-0A	Connecting cable, 14-pole 8mm
3RA6932-0A	Connecting cable, 10-pole 8mm
3RA6933-0B	Connecting cable, 10-pole 200mm
3RA6933-0C	Connecting cable, 14-pole 200mm



3RA6935-0A	Operator panel for Sirius devices with IO-Link
3RA6936-0A	Enabling module for OP 3RA6935-0A
3RA6936-0B	Blanking covers
3RA6933-0A	Connecting cable, 10-pole 2000mm



3RK1005-0LB00-0AA0	Simatic DP module for ET 200S, 4SI, IO-Link master for 3RA64 & 3RA65 compact starters
---------------------------	---

3RA6 Infeed System

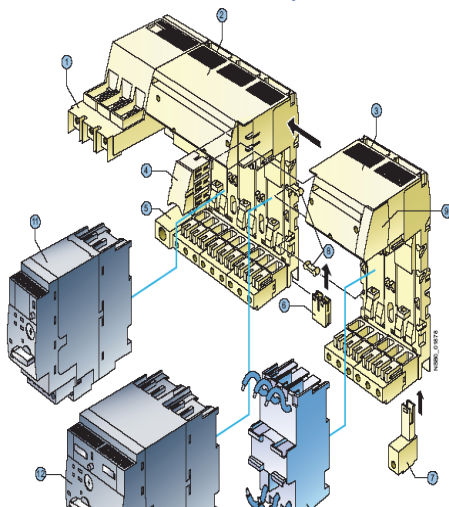











- ① Feeder terminal
- ② Three-socket expansion module
- ③ Two-socket expansion module
- ④ Expansion plug
- ⑤ PE infeed
- ⑥ PE expansion plug
- ⑦ PE pick-off
- ⑧ Connecting wedges
- ⑨ End cover
- ⑩ 45 mm adapter for SIRIUS motor starter protector size S0
- ⑪ 3RA61 direct-on-line starter
- ⑫ 3RA62 reversing starter

3RA6812-8AB	Infeed on the left, connection main circuit, screw terminal, 3 slots for compact load feeders. Terminal max 25mm ² / 35mm ²
--------------------	---



3RA6 Infeed System

Part Number	Description	
3RA6 Infeed System		
3RA6822-0AB	2-socket expansion modules with screw connection. Either 2 DOL or 1 reversing 3RA6	
3RA6823-0AB	3-socket expansion modules with screw connection for 2 DOL's & 1 reversing OR 3 DOL starters	
3RA6860-6AB	PE infeed 25/35mm ² with screw connection	
3RA6870-4AB	PE pick-offs 6/10mm ² with screw terminals	
3RA6890-0EA	PE expansion plugs	
3RA6890-1AB	Expansion plugs between 2 expansion modules	
3RA6890-1AA	Expansion plugs for Sirius 3RV19 infeed system	
3RA6890-0BA	Expansion plugs for Sirius 3RV19 infeed system	
3RV1917-5D	Terminal Block	
3RV2908-1A	Tools for opening spring-type terminal	

INDUSTRIAL CONTROLS

Fuseless Load feeder selection tables - 400V + 10%

Type-2 400V(+/-10%) Class 10 with standard Overload - (IE3 4-pole Motors)

kW Rating	Circuit Breaker	Contactor (220V AC)		Overload
		kA		
0.06kW @ 0.2A	3RV2011-0CA10	3RT2015-1AP01	150	3RU2116-0CB0
0.09kW @ 0.3A	3RV2011-0EA10	3RT2015-1AP01	150	3RU2116-0EB0
0.12kW @ 0.4A	3RV2011-0FA10	3RT2015-1AP01	150	3RU2116-0FB0
0.18kW @ 0.6A	3RV2011-0HA10	3RT2015-1AP01	150	3RU2116-0HB0
0.25kW @ 0.85A	3RV2011-0JA10	3RT2015-1AP01	150	3RU2116-0JB0
0.37kW @ 1.1A	3RV2011-0KA10	3RT2015-1AP01	150	3RU2116-0KB0
0.55kW @ 1.5A	3RV2011-1AA10	3RT2015-1AP01	150	3RU2116-1AB0
0.75kW @ 1.9A	3RV2011-1CA10	3RT2015-1AP01	150	3RU2116-1CB0
1.1kW @ 2.7A	3RV2011-1DA10	3RT2015-1AP01	150	3RU2116-1DB0
1.5kW @ 3.6A	3RV2011-1FA10	3RT2024-1AP00	150	3RU2126-1FB0
2.2kW @ 5A	3RV2011-1GA10	3RT2024-1AP00	150	3RU2126-1GB0
3kW @ 6.5A	3RV2011-1HA10	3RT2024-1AP00	150	3RU2126-1HB0
4kW @ 8.5A	3RV2011-1KA10	3RT2024-1AP00	150	3RU2126-1KB0
5.5kW @ 11.5A	3RV2011-4AA10	3RT2026-1AP00	150	3RU2126-4AB0
7.5kW @ 15.5A	3RV2021-4CA10	3RT2027-1AP00	150	3RU2126-4BB0
11kW @ 22A	3RV2021-4NA10	3RT2027-1AP00	150	3RU2126-4DB0
15kW @ 29A	3RV2031-4UA10	3RT2035-1AP00	100	3RU2136-4EB0
18.5kW @ 35A	3RV2031-4VA10	3RT2036-1AP00	100	3RU2136-4FB0
22kW @ 41A	3RV2031-4WA10	3RT2036-1AP00	100	3RU2136-4GB0
30kW @ 55A	3RV1041-4LA10	3RT1046-1AP00	50	3RU1146-4JB0
30kW @ 55A	3RV1042-4LA10	3RT1054-1AP36	100	3RU1146-4JB0
37kW @ 66A	3RV1041-4MA10	3RT1046-1AP00	50	3RU1146-4KB0
37kW @ 66A	3RV1042-4MA10	3RT1054-1AP36	100	3RU1146-4KB0
45kW @ 85A	3VL2710-2DK33-0AA0	3RT1054-1AP36	50	3RB2056-1F..
45kW @ 85A	3VL2710-3DK33-0AA0	3RT1054-1AP36	100	3RB2056-1FW2
55kW @ 97A	3VL2716-2DK33-0AA0	3RT1054-1AP36	50	3RB2056-1F..
55kW @ 97A	3VL2716-3DK33-0AA0	3RT1056-6AP36	100	3RB2056-1F..
75kW @ 132A	3VL3725-2DK36-0AA0	3RT1056-6AP36	50	3RB2056-1F..
75kW @ 132A	3VL3725-3DK36-0AA0	3RT1064-6AP36	100	3RB2056-1F..
90kW @ 160A	3VL3725-2DK36-0AA0	3RT1056-6AP36	50	3RB2056-1F..
90kW @ 160A	3VL3725-3DK36-0AA0	3RT1064-6AP36	100	3RB2066-1GC2
110kW @ 195A	3VL4731-2DK36-0AA0	3RT1065-6AP36	50	3RB2066-1GC2
110kW @ 195A	3VL4731-3DK36-0AA0	3RT1075-6AP36	100	3RB2066-1GC2
132kW @ 230A	3VL5750-2DK36-0AA0	3RT1075-6AP36	50	3RB2066-1MC2
132kW @ 230A	3VL5750-3DK36-0AA0	3RT1075-6AP36	100	3RB2066-1MC2
160kW @ 285A	3VL5750-2DK36-0AA0	3RT1075-6AP36	50	3RB2066-1MC2
160kW @ 285A	3VL5750-3DK36-0AA0	3RT1076-6AP36	100	3RB2066-1MC2
45kW @ 85A	3VA2216-7MS32-0AA0	3RT1054-1AP36	150	3RB2056-1FW2
55kW @ 97A	3VA2216-7MS32-0AA0	3RT1054-1AP36	150	3RB2056-1FW2
75kW @ 132A	3VA2220-7MS32-0AA0	3RT1056-6AP36	150	3RB2056-1FC2
90kW @ 160A	3VA2220-7MS32-0AA0	3RT1056-6AP36	150	3RB2056-1FC2
110kW @ 195A	3VA2325-7MS32-0AA0	3RT1064-6AP36	150	3RB2066-1GC2
132kW @ 230A	3VA2440-7MS32-0AA0	3RT1065-6AP36	150	3RB2066-1GC2
160kW @ 285A	3VA2440-7MS32-0AA0	3RT1066-6AP36	150	3RB2066-1MC2
200kW @ 350A	3VA2450-7MS32-0AA0	3RT1075-6AP36	150	3RB2066-1MC2
250kW @ 430A	3VA2450-7MS32-0AA0	3RT1076-6AP36	150	3RB2066-1MC2

Type-1 400V(+/-10%) 50kA Class 10 with standard Overload

Rating	MCCB	Contactor	Overload
315kW @ 540A	3VL7712-1DE36-0AA0	3TF6844-0CM7	50 3RB2066-1MC2
355kW @ 610A	3VL7712-1DE36-0AA0	3TF6844-0CM7	50 3RB2066-1MC2

INDUSTRIAL CONTROLS

Fuseless Load feeder selection tables - 400V + 10%

Type-2 400V(+/-10%) Class 10 with Electronic Overload - (IE3 4-pole Motors)

kW Rating	Circuit Breaker	Contactor (220V AC)	kA	Overload
0.06kW @ 0.2A	3RV2011-0CA10	3RT2015-1AP01	150	3RB3016-1RB0
0.09kW @ 0.3A	3RV2011-0EA10	3RT2015-1AP01	150	3RB3016-1RB0
0.12kW @ 0.4A	3RV2011-0FA10	3RT2015-1AP01	150	3RB3016-1NB0
0.18kW @ 0.6A	3RV2011-0HA10	3RT2015-1AP01	150	3RB3016-1NB0
0.25kW @ 0.85A	3RV2011-0JA10	3RT2015-1AP01	150	3RB3016-1NB0
0.37kW @ 1.1A	3RV2011-0KA10	3RT2015-1AP01	150	3RB3016-1NB0
0.55kW @ 1.5A	3RV2011-1AA10	3RT2015-1AP01	150	3RB3016-1PB0
0.75kW @ 1.9A	3RV2011-1CA10	3RT2015-1AP01	150	3RB3016-1PB0
1.1kW @ 2.7A	3RV2011-1DA10	3RT2015-1AP01	150	3RB3016-1PB0
1.5kW @ 3.6A	3RV2011-1FA10	3RT2024-1AP00	150	3RB3026-1SB0
2.2kW @ 5A	3RV2011-1GA10	3RT2024-1AP00	150	3RB3026-1SB0
3kW @ 6.5A	3RV2011-1HA10	3RT2024-1AP00	150	3RB3026-1SB0
4kW @ 8.5A	3RV2011-1KA10	3RT2024-1AP00	150	3RB3026-1SB0
5.5kW @ 11.5A	3RV2011-4AA10	3RT2026-1AP00	150	3RB3026-1QB0
7.5kW @ 15.5A	3RV2021-4CA10	3RT2027-1AP00	150	3RB3026-1QB0
11kW @ 22A	3RV2021-4NA10	3RT2027-1AP00	150	3RB3026-1QB0
15kW @ 29A	3RV2031-4UA10	3RT2035-1AP00	100	3RB3036-1UB0
18.5kW @ 35A	3RV2031-4VA10	3RT2036-1AP00	100	3RB3036-1UB0
22kW @ 41A	3RV2031-4WA10	3RT2036-1AP00	100	3RB3036-1UB0
30kW @ 55A	3RV1041-4LA10	3RT1046-1AP00	50	3RB2046-1EB0
30kW @ 55A	3RV1042-4LA10	3RT1054-1AP36	100	3RB2046-1EB0
37kW @ 66A	3RV1041-4MA10	3RT1046-1AP00	50	3RB2046-1EB0
37kW @ 66A	3RV1042-4MA10	3RT1054-1AP36	100	3RB2046-1EB0
45kW @ 85A	3VL2710-2DK33-0AA0	3RT1054-1AP36	50	3RB2056-1F..
45kW @ 85A	3VL2710-3DK33-0AA0	3RT1054-1AP36	100	3RB2056-1F..
55kW @ 97A	3VL2716-2DK33-0AA0	3RT1054-1AP36	50	3RB2056-1F..
55kW @ 97A	3VL2716-3DK33-0AA0	3RT1056-6AP36	100	3RB2056-1F..
75kW @ 132A	3VL3725-2DK36-0AA0	3RT1056-6AP36	50	3RB2056-1F..
75kW @ 132A	3VL3725-3DK36-0AA0	3RT1064-6AP36	100	3RB2056-1F..
90kW @ 160A	3VL3725-2DK36-0AA0	3RT1056-6AP36	50	3RB2056-1F..
90kW @ 160A	3VL3725-3DK36-0AA0	3RT1064-6AP36	100	3RB2066-1GC2
110kW @ 195A	3VL4731-2DK36-0AA0	3RT1065-6AP36	50	3RB2066-1GC2
110kW @ 195A	3VL4731-3DK36-0AA0	3RT1075-6AP36	100	3RB2066-1GC2
132kW @ 230A	3VL5750-2DK36-0AA0	3RT1075-6AP36	50	3RB2066-1MC2
132kW @ 230A	3VL5750-3DK36-0AA0	3RT1075-6AP36	100	3RB2066-1MC2
160kW @ 285A	3VL5750-2DK36-0AA0	3RT1075-6AP36	50	3RB2066-1MC2
160kW @ 285A	3VL5750-3DK36-0AA0	3RT1076-6AP36	100	3RB2066-1MC2
45kW @ 85A	3VA2216-7MS32-0AA0	3RT1054-1AP36	150	3RB2056-1FW2
55kW @ 97A	3VA2216-7MS32-0AA0	3RT1054-1AP36	150	3RB2056-1FW2
75kW @ 132A	3VA2220-7MS32-0AA0	3RT1056-6AP36	150	3RB2056-1FC2
90kW @ 160A	3VA2220-7MS32-0AA0	3RT1056-6AP36	150	3RB2056-1FC2
110kW @ 195A	3VA2325-7MS32-0AA0	3RT1064-6AP36	150	3RB2066-1GC2
132kW @ 230A	3VA2440-7MS32-0AA0	3RT1065-6AP36	150	3RB2066-1GC2
160kW @ 285A	3VA2440-7MS32-0AA0	3RT1066-6AP36	150	3RB2066-1MC2
200kW @ 350A	3VA2450-7MS32-0AA0	3RT1075-6AP36	150	3RB2066-1MC2
250kW @ 430A	3VA2450-7MS32-0AA0	3RT1076-6AP36	150	3RB2066-1MC2

Type-1 400V(+/-10%) 50kA Class 10 with standard Overload

Rating	MCCB	Contactor		Overload
315kW @ 540A	3VL7712-1DE36-0AA0	3TF6844-OCM7	50	3RB2066-1MC2
355kW @ 610A	3VL7712-1DE36-0AA0	3TF6844-OCM7	50	3RB2066-1MC2

INDUSTRIAL CONTROLS

Fuseless Load feeder selection tables - 400V + 10%

Type-2 400V(+/-10%) 50kA Class 10 with 3UF7 SIMOCODE - (IE3 4-pole Motors)

kW Rating	Circuit Breaker	Contactor (220V AC)	kA	Add Simocode BU or 3RB22
0.09 - 0.55	3RV2311-1BC10	3RT2015-1AP01	150	3UF71*0-1AA00-0 / 3RB2906-2BG1
0.75 - 1.1	3RV2311-1EC10	3RT2015-1AP01	100	3UF71*1-1AA00-0 / 3RB2906-2DG1
1.5	3RV2311-1GC10	3RT2024-1AP00		
2.2 - 3	3RV2311-1JC10	3RT2024-1AP00		
4	3RV2311-1KC10	3RT2024-1AP00		
5.5	3RV2311-4AC10	3RT2026-1AP00		
7.5	3RV2321-4CC10	3RT2027-1AP00		
11	3RV2321-4EC10	3RT2027-1AP00	150	
15	3RV2331-4VC10	3RT2036-1AP00	100	
18.5	3RV2031-4WB10	3RT2036-1AP00	100	3UF71*2-1AA00-0 / 3RB2906-2JG1
22	3RV1342-4JC10	3RT1054-1AP36	100	
30	3RV1342-4LC10	3RT1054-1AP36	100	
18.5 - 30	3RV1041-4LA10	3RT1046-1AP00	50	
37	3VL2716-3DK33-0AA0	3RT1054-1AP36	100	3UF71*3-1BA00-0 / 3RB2906-2JG1
45	3VL2716-3DK33-0AA0	3RT1054-1AP36	100	
55	3VL2716-3DK33-0AA0	3RT1054-1AP36	100	
37 - 45	3VL2710-2DK33-0AA0	3RT1054-1AP36	50	
55	3VL2716-2DK33-0AA0	3RT1054-1AP36	50	
75	3VL3725-2DK36-0AA0	3RT1056-6AP36	50	3UF71*3-1BA00-0 / 3RB2956-2TG2
75	3VL3725-3DK36-0AA0	3RT1056-6AP36	100	
90	3VL3725-2DK36-0AA0	3RT1056-6AP36	50	
90	3VL3725-3DK36-0AA0	3RT1056-6AP36	100	
110	3VL4731-2DK36-0AA0	3RT1065-6AP36	50	3UF71*4-1BA00-0 / 3RB2966-2WH2
110	3VL3725-3DK36-0AA0	3RT1075-6AP36	100	
132	3VL5750-2DK36-0AA0	3RT1075-6AP36	50	
132	3VL5750-3DK36-0AA0	3RT1075-6AP36	100	
160	3VL5750-2DK36-0AA0	3RT1075-6AP36	50	
160	3VL5750-3DK36-0AA0	3RT1075-6AP36	100	
185 - 315	3VL7712-1DE36-0AA0	3TF6844-0CM7	50	
45	3VA2216-7MS32-0AA0	3RT1054-1AP36	150	3UF71*3-1BA00-0 / 3RB2956-2TG2
55	3VA2216-7MS32-0AA0	3RT1054-1AP36	150	
75	3VA2220-7MS32-0AA0	3RT1056-6AP36	150	
90	3VA2220-7MS32-0AA0	3RT1056-6AP36	150	
110	3VA2325-7MS32-0AA0	3RT1064-6AP36	150	3UF71*4-1BA00-0 / 3RB2966-2WH2
132	3VA2440-7MS32-0AA0	3RT1065-6AP36	150	
160	3VA2440-7MS32-0AA0	3RT1066-6AP36	150	
200	3VA2450-7MS32-0AA0	3RT1075-6AP36	150	
250	3VA2450-7MS32-0AA0	3RT1076-6AP36	150	
355kW @ 610A	3VL7712-1DE36-0AA0	3TF6844-0CM7	50	

Type-1 400V(+/-10%) 50kA Class 10 with standard Overload

Rating	MCCB	Contactor	Overload
355kW @ 610A	3VL7712-1DE36-0AA0	3TF6844-0CM7	50

<https://support.industry.siemens.com>

INDUSTRIAL CONTROLS

Fuseless Load feeder selection tables - 500V + 10%

Type-2 525V(+/-5%) Class 10 with standard Overload - (IE3 4-pole Motors)

kW Rating	Circuit Breaker	Contactor (220V AC)	kA	Overload
0.12kW @ 0.3A	3RV2011-0EA10	3RT2015-1AP01	100	3RU2116-0EB0
0.18kW @ 0.5A	3RV2011-0FA10	3RT2015-1AP01	100	3RU2116-0FB0
0.25kW @ 0.7A	3RV2011-0HA10	3RT2015-1AP01	100	3RU2116-0HB0
0.37kW @ 0.9A	3RV2011-0JA10	3RT2015-1AP01	100	3RU2116-0JB0
0.55kW @ 1.2A	3RV2011-1AA10	3RT2015-1AP01	100	3RU2116-1AB0
0.75kW @ 1.5A	3RV2011-1CA10	3RT2015-1AP01	100	3RU2116-1BB0
1.1kW @ 2.2A	3RV2011-1DA10	3RT2015-1AP01	100	3RU2116-1CB0
1.5kW @ 2.9A	3RV2011-1FA10	3RT2024-1AP00	100	3RU2126-1DB0
2.2kW @ 4A	3RV2011-1GA10	3RT2024-1AP00	100	3RU2126-1FB0
3kW @ 5.2A	3RV2011-1JA10	3RT2026-1AP00	100	3RU2126-1GB0
4kW @ 6.8A	3RV2011-1KA10	3RT2026-1AP00	100	3RU2126-1HB0
5.5kW @ 9.2A	3RV2011-4AA10	3RT2026-1AP00	100	3RU2126-1JB0
7.5kW @ 12.4A	3RV2021-4BA10	3RT2027-1AP00	100	3RU2126-4AB0
11kW @ 17.6A	3RV2021-4NA10	3RT2027-1AP00	100	3RU2126-4BB0
15kW @ 23A	3RV2031-4PA10	3RT2035-1AP00	70	3RU2136-4DB0
18.5kW @ 28A	3RV2031-4UA10	3RT2036-1AP00	70	3RU2136-4EB0
22kW @ 33A	3RV2031-4WA10	3RT2036-1AP00	70	3RU2136-4FB0
30kW @ 44A	3RV1041-4KA10	3RT1044-1AP00	50	3RU1146-4HB0
30kW @ 44A	3RV2031-4JA10	3RT2037-1AP00	70	3RU2136-4HB0
37kW @ 53A	3RV1041-4LA10	3RT1045-1AP00	50	3RU1146-4JB0
45kW @ 64A	3VL2710-3DK33-0AA0	3RT1054-1AP36	50	3RB2056-1F..
55kW @ 78A	3VL2716-3DK33-0AA0	3RT1054-1AP36	50	3RB2056-1F..
75kW @ 106A	3VL2716-3DK33-0AA0	3RT1054-1AP36	50	3RB2056-1F..
90kW @ 128A	3VL2716-3DK33-0AA0	3RT1055-1AP36	50	3RB2056-1F..
110kW @ 156A	3VL3725-3DK33-0AA0	3RT1056-6AP36	50	3RB2066-1GC2
132kW @ 184A	3VL4731-3DK36-0AA0	3RT1065-6AP36	50	3RB2066-1GC2
160kW @ 224A	3VL5750-3DK36-0AA0	3RT1075-6AP36	50	3RB2066-1MC2
200kW @ 280A	3VL5750-3DK36-0AA0	3RT1075-6AP36	50	3RB2066-1MC2

Type-1 525V(+/-5%) Class 10 with standard Overload - (IE3 4-pole Motors)

Rating	MCCB	Contactor	kA	Overload
250 - 355kW	3VL7712-2DE36-0AA0	3TF6844-0CM7	50	3RB2066-2MC2

<https://support.industry.siemens.com>

INDUSTRIAL CONTROLS

Fuseless Load feeder selection tables - 500V + 10%

Type-2 525V(+/-5%) Class 10 with Electronic Overload - (IE3 4-pole Motors)

kW Rating	Circuit Breaker	Contactor (220V AC)	kA	Overload
0.12kW @ 0.3A	3RV2011-0EA10	3RT2015-1AP01	100	3RB3016-1NB0
0.18kW @ 0.5A	3RV2011-0FA10	3RT2015-1AP01	100	3RB3016-1NB0
0.25kW @ 0.7A	3RV2011-0HA10	3RT2015-1AP01	100	3RB3016-1NB0
0.37kW @ 0.9A	3RV2011-0JA10	3RT2015-1AP01	100	3RB3016-1NB0
0.55kW @ 1.2A	3RV2011-1AA10	3RT2015-1AP01	100	3RB3016-1PB0
0.75kW @ 1.5A	3RV2011-1CA10	3RT2015-1AP01	100	3RB3016-1PB0
1.1kW @ 2.2A	3RV2011-1DA10	3RT2015-1AP01	100	3RB3016-1PB0
1.5kW @ 2.9A	3RV2011-1FA10	3RT2024-1AP00	100	3RB3026-1SB0
2.2kW @ 4A	3RV2011-1GA10	3RT2024-1AP00	100	3RB3026-1SB0
3kW @ 5.2A	3RV2011-1JA10	3RT2026-1AP00	100	3RB3026-1SB0
4kW @ 6.8A	3RV2011-1KA10	3RT2026-1AP00	100	3RB3026-1SB0
5.5kW @ 9.2A	3RV2011-4AA10	3RT2026-1AP00	100	3RB3026-1SB0
7.5kW @ 12.4A	3RV2021-4BA10	3RT2027-1AP00	100	3RB3026-1QB0
11kW @ 17.6A	3RV2021-4NA10	3RT2027-1AP00	100	3RB3026-1QB0
15kW @ 23A	3RV2031-4PA10	3RT2035-1AP00	70	3RB3036-1UB0
18.5kW @ 28A	3RV2031-4UA10	3RT2036-1AP00	70	3RB3036-1UB0
22kW @ 33A	3RV2031-4WA10	3RT2036-1AP00	70	3RB3036-1UB0
30kW @ 44A	3RV1041-4KA10	3RT1044-1AP00	50	3RB2046-1EB0
30kW @ 44A	3RV2031-4JA10	3RT2037-1AP00	70	3RB3036-1UB0
37kW @ 53A	3RV1041-4LA10	3RT1045-1AP00	50	3RB2046-1EB0
45kW @ 64A	3VL2710-3DK33-0AA0	3RT1054-1AP36	50	3RB2056-1F..
55kW @ 78A	3VL2716-3DK33-0AA0	3RT1054-1AP36	50	3RB2056-1F..
75kW @ 106A	3VL2716-3DK33-0AA0	3RT1054-1AP36	50	3RB2056-1F..
90kW @ 128A	3VL2716-3DK33-0AA0	3RT1055-1AP36	50	3RB2056-1F..
110kW @ 156A	3VL3725-3DK33-0AA0	3RT1056-6AP36	50	3RB2066-1GC2
132kW @ 184A	3VL4731-3DK36-0AA0	3RT1065-6AP36	50	3RB2066-1GC2
160kW @ 224A	3VL5750-3DK36-0AA0	3RT1075-6AP36	50	3RB2066-1MC2
200kW @ 280A	3VL5750-3DK36-0AA0	3RT1075-6AP36	50	3RB2066-1MC2

Type-1 525V(+/-5%) Class 10 with standard Overload - (IE3 4-pole Motors)

Rating	MCCB	Contactor	Overload
250 - 355kW	3VL7712-2DE36-0AA0	3TF6844-0CM7	50 3RB2066-2MC2

Fuseless Load feeder selection tables - 500V + 10%

Type-2 525V(+/-5%) 50kA Class 10 with 3UF7 SIMOCODE - (IE3 4-pole Motors)

kW Rating	Circuit Breaker	Contactor (220V AC)	kA	Add Simocode BU or 3RB22
0.12 - 0.75	3RV2311-1CC10	3RT2015-1AP01	150	3UF71*0-1AA00-0 / 3RB2906-2BG1
1.1 - 1.5	3RV2311-1FC10	3RT2024-1AP00	100	3UF71*1-1AA00-0 / 3RB2906-2DG1
2.2 - 4	3RV2311-1JC10	3RT2026-1AP00		
5.5 - 11	3RV2321-4EC10	3RT2027-1AF00	100	
15 - 18.5	3RV2331-4VC10	3RT2036-1AP00	70	3UF71*2-1AA00-0 / 3RB2906-2JG1
22	3RV2331-4WC10	3RT2036-1AP00	70	
30	3RV1341-4LC10	3RT1045-1AP00	50	
37 - 45	3VL2710-3DK33-0AA0	3RT1054-1AP36	50	
55	3VL2716-3DK33-0AA0	3RT1054-1AP36	50	3UF71*3-1BA00-0 / 3RB2956-2TG2
75	3VL2716-3DK33-0AA0	3RT1055-6AP36	50	
90	3VL2716-3DK33-0AA0	3RT1056-6AP36	50	
110	3VL3725-3DK36-0AA0	3RT1064-6AP36	50	
132	3VL4731-3DK36-0AA0	3RT1066-6AP36	50	3UF71*4-1BA00-0 / 3RB2966-2TW2
160	3VL5750-3DK36-0AA0	3RT1075-6AP36	50	
200	3VL5750-3DK36-0AA0	3RT1075-6AP36	50	

Type-2 525V(+/-5%) 50kA Class 10 with 3UF7 SIMOCODE - (IE3 4-pole Motors)

Rating	MCCB	Contactor	Overload
250 - 400	3VL7712-2DE36-0AA0	3TF6844-0CM7	50
			3UF71*4-1BA00-0 / 3RB2966-2TW2
500	3VL8716-2DE30-0AA0	3TF6944-0CM7	50
			3UF1868-3GA00 + 3UF7100-1AA0 / 3UF1868-3GA00 + 3RB29 06-2BG1

INDUSTRIAL CONTROLS

Fuseless Load feeder selection tables - 550V & 690V + 5%

Type-2 550V(+/-5%) 50kA Class 10 with 3RB22 / 3UF7 Electronic Overload - (IE3 4-pole Motors)

Rating kW	Circuit Breaker	AC)	kA	Add 3RB22 / 3UF7
0.37 - 0.55	3RV1353-6BP10	3RT1024-1AP00	50	3UF71*0-1AA00-0 / 3RB2906-2BG1
0.75 - 1.1	3RV1353-6DP10	3RT1026-1AP00	50	
1.5 - 11	3RV1353-6MM10	3RT1034-1AP00	50	3UF71*1-1AA00-0 / 3RB2906-2DG1
15 - 22	3RV1363-7AN10	3RT1054-1AF36	50	3UF71*2-1AA00-0 / 3RB2906-2JG1
30 - 45	3RV1363-7CN10	3RT1054-1AF36		3UF71*3-1BA00-0 / 3RB2956-2TG2
55	3RV1363-7EN10	3RT1055-6AF36		
75	3RV1363-7EN10	3RT1056-6AF36		
90	3RV1363-7EN10	3RT1056-6AF36		
110	3RV1373-7GN10	3RT1065-6AF36	50	3UF71*4-1BA00-0 / 3RB2966-2WH2
132	3RV1373-7GN10	3RT1065-6AF36	50	
160	3RV1373-7JN10	3RT1075-6AF36	50	
185	3RV1373-7JN10	3RT1075-6AF36	50	
200	3RV1373-7JN10	3RT1075-6AF36	50	
250	3RV1383-7KN10	3RT1076-6AF36	50	
280	3RV1383-7KN10	3RT1076-6AF36	50	

Type-2 690V (+/-5%) Class 10 with 3UF7 or 3RB22 Electronic overload - (IE3 4-pole Motors)

Rating @ 550V	Circuit Breaker	Contactor (220V AC)	kA	Add 3RB22 / 3UF7
0.37 - 0.75kW @ 1A	3RV2311-1BC10	3RT2015-1AP01	100	3UF71*0-1AA00-0 / 3RB2906-2BG1
1.1 - 7.5kW @ 9.8A	3RV2031-4TB10	3RT2035-1AP00	70	3UF71*1-1AA00-0 / 3RB2906-2DG1
11 - 18.5kW @ 25A	3RV2031-4VB10 + 3RV2331-4RC10	3RT2037-1AP00	70	3UF71*2-1AA00-0 / 3RB2906-2JG1
22kW @ 30A	3RV2031-4WB10 + 3RV2331-4RC10	3RT2037-1AP00	70	3UF71*2-1AA00-0 / 3RB2906-2JG1
30kW @ 40A	3RV1364-7AN10	3RT1055-6AP36	80	3UF71*3-1BA00-0 / 3RB2956-2TG2
37 - 55kW @ 71A	3RV1364-7CN10	3RT1055-6AP36	80	
75 - 90kW @ 116A	3RV1364-7EN10	3RT1064-6AP36	80	3UF71*4-1BA00-0 / 3RB2966-2WH2
110kW @ 142A	3RV1364-7EN10	3RT1064-6AP36	80	
132kW @ 167A	3RV1374-7GN10	3RT1065-6AP36	70	
160kW @ 204A	3RV1373-7JN10	3RT1075-6AP36	70	
200kW @ 255A	3RV1373-7JN10	3RT1075-6AP36	70	
		3RT1076-6AP36	35	
250 - 280kW @ 372A	3RV1383-7KN10	3RT1076-6AP36	35	

<https://support.industry.siemens.com>

Siemens Limited

Siemens Park

300 Janadel Avenue, Halfway House

Private Bag X71, Halfway House, 1685

Tel: 0860 80 80 80

email: lvswitchgear.za@siemens.com